

**COST – BENEFIT ANALYSIS OF BLIND SPOT  
MIRRORS**


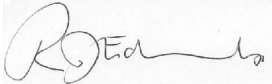
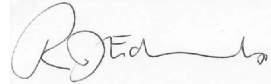
**Final Report**


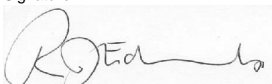
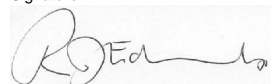
August 2004

---

**DOCUMENT CONTROL SHEET**

**Client:** EC DG TREN  
**Project:** COST – BENEFIT ANALYSIS ON BLIND SPOT MIRRORS **Job No:** J22332A  
**Title:** FINAL REPORT

<b>ORIGINAL</b>	<b>Prepared by</b>	<b>Reviewed by</b>	<b>Approved by</b>
	Name <b>TIM O'BRIEN</b>	Name <b>RICHARD EDMUNDS</b>	Name <b>RICHARD EDMUNDS</b>
Date 30/08/04	Signature 	Signature 	Signature 
Path and Filename	P:\J22332A Call-OFF TREN Lot 2 & 3\Blind Spot Mirrors\Project\Report\Final\Final Report 01Nov04.doc		

<b>REVISION</b>	<b>Prepared by</b>	<b>Reviewed by</b>	<b>Approved by</b>
	Name <b>TIM O'BRIEN</b>	Name <b>RICHARD EDMUNDS</b>	Name <b>RICHARD EDMUNDS</b>
Date 20/10/04	Signature 	Signature 	Signature 
Path and Filename			

<b>REVISION</b>	<b>Prepared by</b>	<b>Reviewed by</b>	<b>Approved by</b>
	Name	Name	Name
Date	Signature	Signature	Signature
Path and Filename			

This report, and information or advice which it contains, is provided by Jacobs Consultancy solely for internal use and reliance by its Client in performance of Jacobs Consultancy's duties and liabilities under its contract with the Client. Any advice, opinions, or recommendations within this report should be read and relied upon only in the context of the report as a whole. The advice and opinions in this report are based upon the information made available to Jacobs Consultancy at the date of this report and on current UK standards, codes, technology and construction practices as at the date of this report. Following final delivery of this report to the Client, Jacobs Consultancy will have no further obligations or duty to advise the Client on any matters, including development affecting the information or advice provided in this report. This report has been prepared by Jacobs Consultancy in their professional capacity as Consultants. The contents of the report do not, in any way, purport to include any manner of legal advice or opinion. This report is prepared in accordance with the terms and conditions of Jacobs Consultancy's contract with the Client. Regard should be had to those terms and conditions when considering and/or placing any reliance on this report. Should the Client wish to release this report to a Third Party for that party's reliance, Jacobs Consultancy may, at its discretion, agree to such release provided that:

- (a) Jacobs Consultancy's written agreement is obtained prior to such release, and
- (b) By release of the report to the Third Party, that Third Party does not acquire any rights, contractual or otherwise, whatsoever against Jacobs Consultancy and Jacobs Consultancy, accordingly, assume no duties, liabilities or obligations to that Third Party, and
- (c) Jacobs Consultancy accepts no responsibility for any loss or damage incurred by the Client or for any conflict of Jacobs Consultancy's interests arising out of the Client's release of this report to the Third Party.

## CONTENTS

<b>EXECUTIVE SUMMARY</b>	<b>3</b>
<b>1 INTRODUCTION</b>	<b>3</b>
1.1 Background	3
1.2 Approach	3
1.3 Report contents	3
<b>2 REVIEW OF EXISTING SITUATION</b>	<b>3</b>
2.1 Detailed composition of EC legislation and proposals	3
2.2 Current and proposed situation in individual EU countries	3
<b>3 RESEARCH AND LITERATURE REVIEW</b>	<b>3</b>
3.1 UK	3
3.2 Germany	3
3.3 United States	3
<b>4 STATISTICAL DATA COLLECTION (BASE DATA)</b>	<b>3</b>
4.1 Vehicles	3
4.2 Accidents	3
4.3 Valuation of accidents by type	3
<b>5 FITTING AND RETROFITTING OF MIRRORS</b>	<b>3</b>
5.1 Introduction	3
5.2 Manufacturers in Europe	3
5.3 Fitting of new mirrors and retrofitting to existing vehicles	3
5.4 Costs of fitting new mirrors	3
5.5 Financial cost of retrofitting	3
5.6 Economic cost of retrofitting	3
<b>6 COST BENEFIT ANALYSIS</b>	<b>3</b>
6.1 Methodology	3
6.2 Results of the CBA	3

6.3	Sensitivity tests	3
<b>7</b>	<b>ADDITIONAL OBSERVATIONS</b>	<b>3</b>
7.1	Background	3
7.2	Available data	3
7.3	Practical conclusions on retrofitting	3
	<b>APPENDIX A - TERMS OF REFERENCE</b>	<b>3</b>
	<b>APPENDIX B - CONTACTS</b>	<b>3</b>
	<b>APPENDIX C - REFERENCES</b>	<b>3</b>
	<b>APPENDIX D - TECHNICAL DEFINITIONS</b>	<b>3</b>
	<b>APPENDIX E - ANALYSIS SPREADSHEET</b>	<b>3</b>
	<b>APPENDIX F - QUESTIONNAIRE</b>	<b>3</b>
	<b>APPENDIX G - ACCIDENT VALUATIONS BY TYPE &amp; COUNTRY</b>	<b>3</b>

Figure 1-1 Spreadsheet intra-linkages	3
Figure 2-1 Goods vehicle, bus and coach accidents in the Netherlands, 1997-2002	3
Figure 2-2 Breakdown of HGV accidents in the Netherlands, 1997-2002	3
Figure 3-1 Proposed mirror layout (as applied to continental European vehicle) viewed from inside driver cab	3
Figure 3-2 Cost of Implementation against benefit of casualty saving	3
Figure 3-3 "Blind Spot" accidents as a proportion of total accidents in collisions between cycles/mopeds and goods vehicles, by type of manoeuvre	3
Figure 3-4 Presence of goods vehicles in accidents with cyclists/mopeds	3
Figure 3-5 Detection of potential collision victims	3
Figure 3-6 Grid used for analysis of victim locations	3
Figure 3-7 Goods vehicles involved in small two wheeled accidents	3
Figure 3-8 Regulatory improvements to driver vision in comparison to total accident fatalities in Japan	3
Figure 4-1 Comparison of the average age of vehicle fleet by country in 2000	3
Figure 4-2 Average age of passenger cars and heavy vehicles by country	3
Figure 4-3 Age of vehicle fleet by country	3
Figure 4-4 Scrappage of cars	3
Figure 4-5 Measures of overall accident risk, 2001	3
Figure 4-6 Pedestrian and two-wheeler vehicle activity in EU15 by country	3
Figure 4-7 Measures of population and road concentration by country	3
Figure 6-1 Spreadsheet intra-linkages	3
Figure D 1 EU field of vision requirements for an existing HGV over 7.5 tonnes	3
Figure D 2 Blind spots for existing goods vehicles (>7.5 tonnes) in Holland with no "blind spot" mirror	3
Figure D 3 EU field of vision requirements for an HGV over 7.5 tonnes form Directive 2003/97/EC	3
Figure D 4 Areas of no visibility or impaired visibility with mirrors specified by Directive 2003/97/EC	3
Figure D 5 EU field of vision requirements for existing and new HGVs over 7.5 tonnes	3
Figure D 6 EU field of vision requirements for N2 HGV under 7.5 tonnes, existing and new	3
Figure D 7 EU field of vision requirements for existing and new LGVs (N1)	3
Figure D 8 EU field of vision requirements for existing and new bus and coaches (M2 and M3)	3
Table 2-1 Mirror requirements – goods vehicles*	3
Table 2-2 Mirror requirements – buses*	3
Table 3-1 Fatal accidents involving cycle and moped occupants, 1996	3
Table 3-2 Serious accidents involving cycle and moped occupants, 1996	3
Table 3-3 Location of victims in "blind spot" accidents	3
Table 3-4 Accident victims and proportion of fatal accidents by vehicle type (Berlin)	3
Table 3-5 U.S documents reviewed	3
Table 4-1 Valuation of accidents by type and country*	3
Table 4-2 Estimated EU25 goods vehicle fleets, 2001	3
Table 4-3 Estimated EU25 goods vehicle fleets (%), 2001	3
Table 4-4 UK goods vehicle fleet, 2001	3
Table 4-5 Bus and coach fleets, 2001	3
Table 4-6 EU15 goods vehicle registrations	3
Table 4-7 2002 vehicle fleet by date of first registration	3
Table 4-8 New bus and coach registration growth	3
Table 4-9 New bus and coach registration growth	3
Table 4-10 Annual GDP growth forecasts	3
Table 4-11 Accidents and casualty data for 2001	3
Table 4-12 Fatalities	3

Table 4-13 Injuries	3
Table 4-14 Fatality and accident rates	3
Table 4-15 Two wheeler and pedestrian fatalities as a % of total fatalities, 2001	3
Table 4-16 Two wheeler and pedestrian fatalities as a % of total fatalities, 1999	3
Table 4-17 Two wheeler and pedestrian casualties as a % of total casualties, 1999	3
Table 4-18 Severity of accidents by vehicle type	3
Table 4-19 Pedestrian and cycle accidents, 1992-1997	3
Table 4-20 Fatal accidents involving HGVs and two wheelers or pedestrians in “all areas”*	3
Table 4-21 Fatal accidents involving LGVs and two wheelers or pedestrians in “all areas”*	3
Table 4-22 Fatal accidents involving bus/coaches and two wheelers or pedestrians in “all areas”*	3
Table 4-23 Fatal accidents involving HGVs and two wheelers or pedestrians in “urban areas”*	3
Table 4-24 Fatal accidents involving LGVs and two wheelers or pedestrians in “urban areas”*	3
Table 4-25 Fatal accidents involving bus/coaches and two wheelers or pedestrians in “urban areas”*	3
Table 4-26 Accidents with small two wheelers	3
Table 4-27 Small two wheel victims in Belgium, 1999	3
Table 4-28 Estimated UK accident costs, 2002 (euro)	3
Table 5-1 Vehicles manufactured in Europe, 2001	3
Table 6-1 CBA of Class IV & V mirrors on HGV’s	3
Table 6-2 CBA of Class IV and V mirrors on LGV’s	3
Table 6-3 CBA of Class IV and V mirrors on Buses	3
Table 6-4 CBA of Class VI mirrors on HGV’s	3
Table 6-5 CBA of Class VI mirrors on LGV’s	3
Table 6-6 CBA of Class VI mirrors on Buses	3
Table 6-7 Sensitivity analysis	3
Table 6-8 Delays in implementing retrofit legislation	3
Table D 1 Mirror requirements for existing vehicles	3
Table D 2 Mirror requirements for new vehicles under Directive 2003/97/EC	3

## ABBREVIATIONS

ACEA	Association des Constructeurs Européens d'Automobiles
BIVV	Belgian Road Safety Institute (Belgisch Instituut voor Verkeersveiligheid)
CCFA	Comite des Constructeurs Francais d'Automobiles
CETE	Centre d'Etudes Techniques de l'Equipment du Sud-Ouest (France)
DfT	UK Department for Transport
EEA	European Environment Agency
EU15	the current 15 members of the EU
EU25	the 25 member countries of the EU (from May 2004)
Eurostat	EC statistical body
FARS	Fatality Analysis Reporting System
GDV	Institute for Vehicle Safety, Germany
GVW	gross vehicle weight
HGV	heavy goods vehicle (more than 3.5 tonnes GVW)
IRTAD	International Road Traffic and Accident Database
IRU	International Road Transport Union
LGV	light goods vehicle (less than 3.5 tonnes GVW)
LHD	Left hand drive
NASS	National Accident Sampling System
NHTSA	National Highway Traffic Safety Administration
NPA	National Police Agency (Japan)
NPV	Net present value
PIA	personal injury accident
PRI	Prevention Routiere International
RHD	Right hand drive
STAIRS	Standardisation of Accident and Injury Registration Systems
SWOV	Institute for Road Safety Research, Netherlands
T	tonne
TLN	Dutch Transport Operators Association
TNO	Automotive Research in road vehicles and , Holland
ToR	terms of reference
TRL	Transport Research Laboratory, UK
UNECE	United Nations Economics Council for Europe
VSE	Vehicle Standards and Engineering (division of the UK Road Safety Directorate)
VSRC	Vehicle Safety Research Centre

## EXECUTIVE SUMMARY

### E.1 Introduction

This study has been undertaken by consultants Jacobs Consultancy on behalf of DGTREN under framework contract TREN/CC/04-2002 (Lot 2 Economic assistance activities). The specific order for this assignment is number SER-B27020B-E3-2003-JACOBS-S07.28156 and was signed on 30 December 2003.

The Commission has implemented a directive to make the fitting of mirrors and supplementary systems for indirect vision compulsory for specified vehicle types. The principal objective is to reduce the number of “blind spot” accidents. This directive will only apply to new vehicles. The objective of the study is to assess, by means of cost-benefit analysis, the probable consequences of extending this legislation to cover existing vehicles.

The main tasks were:

- a literature review;
- interviews with stakeholders;
- analysis by spreadsheet.

This report is the final report of the study, reflecting the situation at the end of August 2004.

### E.2 Objectives

The latest directive, **Directive 97/2003/EC**, came into force on 29 January 2004. The objective is to harmonise rules relating to type-approval of devices for indirect vision and vehicles equipped with these devices.

For the purposes of this study, it is assumed to mean that by the end of 2006, all new vehicles being entered into service will be fitted with the new systems. Preliminary responses from manufacturers suggest that the systems will only be fitted when it is compulsory (and therefore that few will be fitted before 2006).

### E.3 Research and literature review

The review was primarily internet-based together with leads from the individuals contacted. Within Europe, substantial relevant material was found for the UK, the Netherlands and Belgium. Research in the new member countries was focused on Poland. Other relevant material was found for Denmark and Germany. Visits were made to the TRL in UK, to the Netherlands and Belgium.

There are various international databases with relevant material. Published data was utilised from several of them. Data was extracted directly from the EC road accident database by the EC DGTREN task manager.

The most significant findings from the literature review were:



**UK** Driver's Field of View from Large Vehicle (ICE Ergonomics, 1999)  
The project concluded that the most cost-effective means for improvement to the driver's field of vision entailed a combination of additional, modified and repositioned mirrors. Their approach was to estimate how many lives would need to be saved to justify the measure and this came to around 13.

**UK** TRL (ongoing)  
This research is currently underway and its objective is to consider the impact of prospective legislation on fitting rear view devices to goods vehicle over 7.5 tonnes.

**Netherlands** Improvement of the Vision of Drivers of Trucks and Vans (TNO, 1998)  
Potential accident savings were calculated resulting in a 43% decrease of "blind spot" fatalities (15 fatalities per year).

**Netherlands** Systems for Improving Fields of Vision for Trucks (TNO, 1999)  
Field test were undertaken to compare "blind spot" devices in terms of the percentage of objects in the "blind spot" detected by the different systems.

**Netherlands** Analysis of Police Reports relating to Field of Vision and Location of Victims (TNO, January 2001)  
Police records were used to show the final resting locations of victims. The results showed that most of the victims are to the rear of the driver's position, up to 2.5 metres out from the cab.

**Netherlands** Fields of Vision related Victims among Small Two-wheeled Vehicles: a European Perspective (TNO, November 2001)  
The analysis of the incidence of heavy vehicles in collisions with cycles and mopeds was extended to other countries in Europe. The most useful data was obtained for Belgium, Germany and the UK.

**Netherlands** Cost Benefit Analysis of Measures to Improve Goods Vehicle Safety Draft Report (SWOV, January 2004)  
SWOV are undertaking a comparative review of the costs and benefits of various measure to improve goods vehicle safety, including retrofitting of blind spot mirrors and cameras.

**Germany** Right Turning Vehicle Accidents in Berlin  
The analysis predicted that annually there are approximately 200 fatal accidents in Germany between right turning trucks and cyclists.

**United States** (several sources)  
Much of the US literature review reveals topics on the periphery of interest to the current study. The discussions tend to be of technical rather than economic issues.

**Japan** National Police Agency  
Japan has introduced the installation of Class IV mirrors to all new trucks to improve driver spatial awareness. Statistics collated by the National Police Agency show that from 1976 the number of fatal accidents caused by left-turning vehicles dropped dramatically over a period of 8 years as the new regulations were implemented.

## E.4 Statistical data collection (Base data)

Statistical data was collected in the following areas:

- Vehicles:
  - Fleet composition;
  - New registrations;
  - Average vehicle age;
  - Age profile;
  - Scrappage;
  - Growth in new vehicle registrations;
  - Future economic (GDP) growth;
  - Manufacturers in Europe;
  - Fitting of new mirrors.
  
- Accidents:
  - Fatalities and PIA;
  - Accident rates;
  - Breakdown by travel mode of victim;
  - Presence of goods vehicles in pedestrian and two wheeler accidents;
  - Right turning two-wheeler accidents;
  - Other characteristics which may influence accident rates.
  
- Valuation of accidents by type.

## E.5 Fitting/retrofitting of mirrors

Enquiries were made of the vehicle manufacturers concerning the introduction of new mirrors and retrofitting to existing vehicles. In summary, the manufacturers are only beginning to come to terms with the new directive requirements and hence have given little thought to retrofitting. However, this situation is changing continuously as manufacturers become more conversant with the directive's requirements.

The new mirrors will be fitted as a package, to cover the fields of vision required by the new directive. It is difficult to separate out the costs of specific mirrors covering the side and front blind spots. It was concluded that only retrofitting of mirrors currently on the market was practicable.

A single estimate was therefore adopted to be included in the analysis for the cost of mirror (including fitting), as follows:

- side-view: €150
- front-view: €150
- camera: €1,000.

it was assumed that taxes and fitting costs cancelled each other out. Straightforward fitting of side-view mirrors was estimated to take one hour, with negligible opportunity cost. Therefore no additional allowance was included.

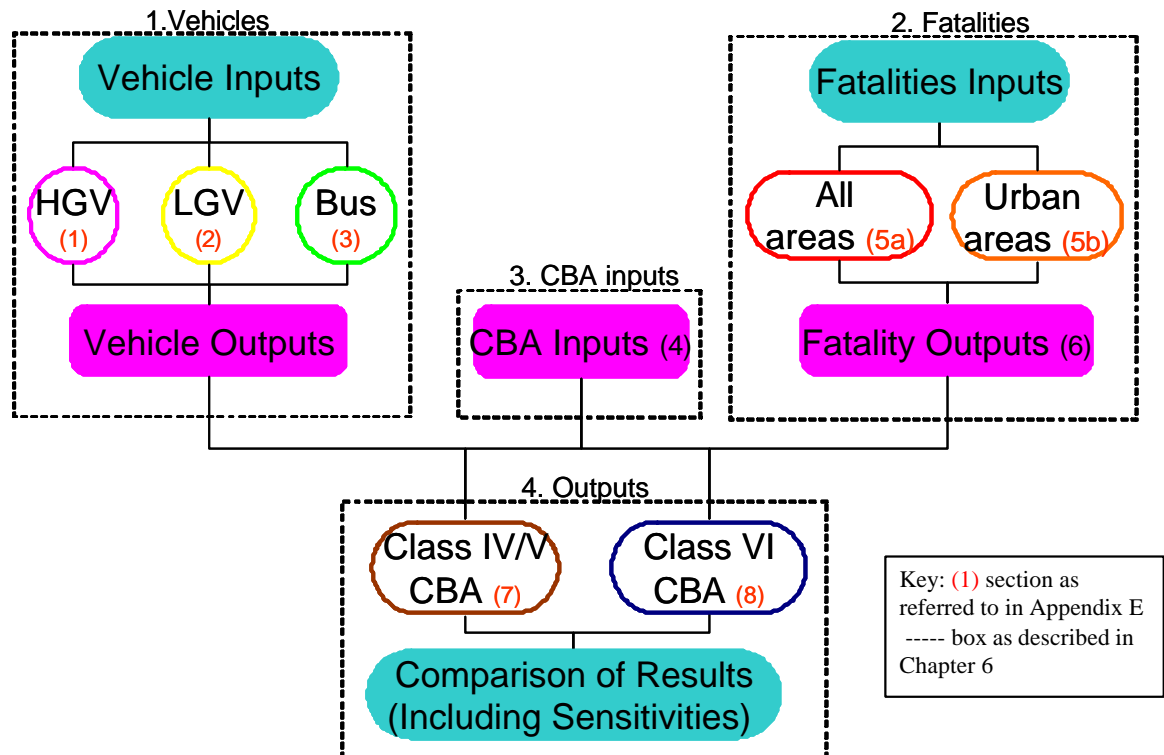
## E.6 Cost benefit analysis

### Methodology

The analysis was undertaken by spreadsheet. The structure of the spreadsheet is shown diagrammatically in Figure 1-1. The analysis was carried out in two parts, for

Class IV (wide angle)/Class V (close proximity) separately from Class VI (front) mirrors. This reflects the two main blind spots.

**Figure 1-1 Spreadsheet intra-linkages**



## Results

### Vehicles

#### A. HGV

From the analysis spreadsheet, the numbers of HGV available for retrofitting in 2006 are 4.4 million and 4.7 million, for class IV/V and class VI mirrors, respectively. The difference is because some HGV are already fitted with Class IV/V mirrors with the range of vision required by the new directive.

#### B. LGV

The LGV fleet available for retrofitting in 2006 is 22.5 million vehicles.

#### C. Buses

The fleet available for retrofitting in 2006 is 0.7 million vehicles.

### Fatalities

Forecast of fatalities saved are:

- highest for HGV, followed by LGV, with buses the smallest;
- higher for Class IV/V mirrors than for Class VI.

## Cost benefit analysis

The principal measure of the economic value of retrofitting is the benefit cost ratio (BCR). The BCRs include discounting of benefits at 5 % per year. The acceptable criterion is that the BCR is greater than 1.0. The results in the following table are for the fitting of Class IV/V mirrors to HGVs.

Country	Fatalities saved*	Total accident cost per fatality (€million)	Undiscounted benefits (€million)	Total mirror costs (€million)	Benefit cost ratio (discounted @5%)
Austria	1.8	3.1	5.7	9.2	0.5
Belgium	0.0	2.9	0.0	0.0	0.0
Denmark	28.1	3.1	86.7	8.8	7.3
Finland	14.1	2.9	41.4	9.9	3.0
France	137.0	2.9	403.2	135.6	2.3
Germany	126.3	2.6	325.9	63.7	4.1
Greece	65.6	2.6	172.1	29.1	4.2
Ireland	2.2	3.1	6.9	9.4	0.6
Italy	402.4	2.9	1,184.3	104.4	8.4
Luxembourg	4.8	3.8	18.3	0.3	61.4
Netherlands	0.0	2.9	0.0	0.0	0.0
Portugal	19.2	2.6	50.4	45.0	0.8
Spain	91.6	2.7	246.8	130.3	1.4
Sweden	23.8	2.9	70.1	12.1	4.1
United Kingdom	95.4	3.3	314.4	57.0	4.5
Total	1,012.4		2,926.3	614.8	3.6
Cyprus	8.1	3.0	24.6	1.8	10.6
Czech Republic	54.5	2.9	156.3	5.0	17.1
Estonia	7.9	2.6	20.7	1.2	10.0
Hungary	34.5	2.8	95.5	6.1	11.2
Latvia	8.1	2.6	20.8	1.6	7.2
Lithuania	11.1	2.6	29.0	1.5	10.6
Malta	19.3	2.9	56.9	0.8	56.2
Poland	142.0	2.6	374.1	30.1	8.1
Slovakia	11.1	2.7	30.0	2.4	6.3
Slovenia	4.0	2.8	11.4	0.8	10.6
Total	300.5		819.4	51.2	10.7
Total	1,312.9		3,745.7	665.9	4.1

\* over evaluation period

In the above table, the colour coding of countries reflects their classification for analysis (large, medium and small). Belgium and the Netherlands have zero benefits because all vehicles are assumed to be retrofitted under existing legislation. There are some unrealistic results for smaller countries, notably Luxembourg and Malta, but generally the results by country are what might be expected.

## Sensitivity tests

The cost-benefit ratios from the sensitivity tests are shown in the following table:

Scenario: for EU25 totals	Side view			Front-view		
	HGV	LGV	Bus	HGV	LGV	Bus
Base case	4.1	0.4	0.4	0.6	0.1	0.2
Cameras rather than mirrors	0.6	0.1	0.1			
Increased mirror Costs + (50%)	2.7	0.2	0.3			
Constant fatality rates	5.5	0.5	0.6			
10% increase in fatality saving (under reporting)	5.3	0.4	0.6			
Urban only areas	2.3	0.2	0.3			

The results support the conclusion that only fitting of side view mirrors to HGV is justified.

## E.7 Additional observations

### Available data

A quantified economic analysis can only be as good as the data available. Despite an extensive literature review and contacts, the necessary data for a robust analysis by type of vehicle and field of vision could not be obtained. Considering the data by type:

- That relating to vehicles can be considered reasonably consistent and reliable.
- Overall fatality and injury information suffers from the limitation noted by some analysts, concerning inconsistencies across the EU related to definitions, methods of collection and under-reporting.
- Potential fatality saving is determined by two critical parameters:
  1. the proportion undertaking critical manoeuvres applicable to the mirror type.
  2. the effectiveness of fitting the mirrors (i.e. the proportion of fatalities and injuries that would be saved).

The only substantial research targeted at these parameters was in Netherlands, for HGV. Extensive assumptions were therefore required.

### Practical conclusions on retrofitting

The analysis is considered to have demonstrated the theoretical viability of retrofitting mirrors to cover the nearside blind spot on HGV. There could be a case for retrofitting to LGV and buses, and for Class VI mirrors. However, our analysis, based on the necessary assumptions, has shown this not to be justified. This generally supports the views from the literature review and interviews.

The analysis shows that retrofitting of Class IV/V mirrors is still justified even if retrofitting is delayed to 2007 or 2008. However, the NPV falls significantly for each year of delay. Also there is a significant overhead cost in retrofitting (development of legislation and perhaps development of suitable mirrors), so the legislation should be introduced as soon as possible for maximum benefit.

The economic analysis could only be undertaken at the level of "Class IV/V" and "Class VI" mirrors. These are essentially broad areas of vision rather than specific mirrors. We were unable to make an assessment of the detailed technical feasibility of retrofitting "new generation" mirrors because these mirrors are still being designed and are largely specific to different manufacturers. Unless this situation changes, the practical solution would therefore appear to be to aim for retrofitting of mirrors with similar specification to those already required in the Netherlands and Belgium.

Finally our research did not show universal support for a policy focusing on new mirrors. The broad consensus, even in the Netherlands, is that associated measures are necessary, particularly publicity and driver education. For example, a badly adjusted mirror may be worse than no mirror at all. EU policy on road safety must recognise this.

# 1 INTRODUCTION

## 1.1 Background

### 1.1.1 Commissioning of the study

This study has been undertaken by consultants Jacobs Consultancy on behalf of DGTREN under framework contract TREN/CC/04-2002 (Lot 2 Economic assistance activities). The specific order for this assignment is number SER-B27020B-E3-2003-JACOBS-S07.28156 and was signed on 30 December 2003.

### 1.1.2 Purpose of the study

The Commission has implemented a directive (Directive 2003/97/EC (**Ref 117**)) to make the fitting of mirrors and supplementary systems for indirect vision compulsory for specified vehicle types. The objective is to reduce the number of "blind spot" accidents. This directive will only apply to new vehicles. The objective of the study is to assess, by means of cost-benefit analysis, the probable consequences of extending this legislation to cover the mandatory retrofit of mirrors and supplementary systems for indirect vision to existing vehicles (N1, N2, N3, M2 and M3).

The alternatives to be analysed, for trucks and buses separately, are that the legislation applies to:

- all relevant existing vehicles;
- particular types of existing vehicles;
- parts of the measures to all or some of the vehicles;
- vehicles up to a certain age;
- not applied.

At the introductory meeting with the EC Task Manager in Brussels, the priorities for study were given as:

- Class V mirrors fitted to N2 (over 7.5T) and N3 vehicles;
- Class VI mirrors fitted to N2 (over 7.5T) and N3 vehicles;
- Class V and VI mirrors fitted to N2 (less than 7.5T) vehicles;
- Class V mirrors fitted to N1 vehicles;
- Class V mirrors fitted to M2 and M3 vehicles.

It was emphasised that if there were a clear case for not pursuing one of the options, then no further analysis would be required.

### 1.1.3 Context

Road safety directly affects all of the territory of the European Union and its inhabitants. In the previous European Union of 15 members, 375 million road users, 200 million of them driving licence holders, use 200 million vehicles on 4 million km of roads. Ever greater mobility comes at a high price. 1.3 million accidents a year cause 40,000 deaths and 1.7 million injuries on the roads. A recent communication from the Commission under the European Road Safety Action Programme (**Ref 57**) estimated the direct and indirect cost of these accidents at €160 billion i.e. 2% of EU GNP. Not only are there a huge economic and financial cost of accidents but also a large human cost. This provides the impetus to introduce more remedial measures at a pan-European level and is the driving force in trying to reduce blind spot accidents.

The Commission's White Paper on Transport set itself the target of halving the number of road deaths by 2010 (**Ref 58**). The objective of this study is to determine whether the compulsory retrofitting of devices for indirect vision can contribute to this target.

## **1.2 Approach**

The following tasks were undertaken:

### **(a) Meetings with the EC task manager in Brussels**

The introductory meeting referred to in section 1.1.1 was followed by an interim meeting during which the course of the study was discussed, and a further meeting to discuss the results of the draft report.

### **(b) Review of relevant directives**

When the ToR were prepared, the new directive was only a proposal. Since January 26 2004, it has been effective as Directive 2003/97/EC (**Ref 117**). A review was completed of the implementation of relevant directives since Directive 71/127/EEC (**Ref 6**).

### **(c) Visits to the TRL in UK and to various organisations and individuals in Belgium and the Netherlands**

This was undertaken and those met are listed in Appendix B. Many of these individuals continued to provide useful information throughout the study.

### **(d) Mirrors on existing vehicles**

Previous directives were not compulsory and national legislation varies by country. The questionnaire in Appendix F was therefore circulated to request this information.

### **(e) Introduction of new mirrors**

Contacts were made with leading vehicle HGV manufacturers to request answers to the following:

- Have you finalised design of a new set of mirrors that will meet the requirements of Directive 2003/97/EC? If so, do you have any sketches of how they will look?
- When will vehicles fitted with the new mirrors start to be available for sale?
- When will all new vehicles be fitted with the mirrors?
- Approximately how much will the new mirrors add to the cost of the vehicle?
- Is it practicable to retrofit new generation mirrors to your existing vehicles?

### **(f) Research and literature review**

The review was primarily internet-based together with leads from the individuals contacted. In general, little of relevance was found outside Europe. Within Europe, substantial relevant material was found for the UK, the Netherlands and Belgium. Research in the new member countries was focused on Poland. Other relevant material was found for Denmark and Germany.

There are various international databases with relevant material. Published data was utilised from several of them. Data was extracted directly from the EC road accident database by the EC DGTREN task manager.

### (g) Technical feasibility and costing of retrofitting

It appears that the mirrors and/or camera systems to be fitted to new vehicles will be a “new generation”. Contact was made with manufacturers to establish whether the new mirrors, as they are being designed, can be retrofitted (see earlier section (e)).

### (h) Cost-benefit analysis spreadsheet

The general approach was as follows:

1. Estimate the numbers of trucks (types N1- N3) and buses (types M2 and M3) in the EU, by country, by size group and by age distribution.
2. Estimate the numbers and proportions of the fleets to be fitted with new generation mirrors, according to the new directive, by year.
3. Determine the time window for retrofitting mirrors.
4. Estimate the potential accident reduction from fitting new mirrors, by country, vehicle type, field of vision etc.
5. Estimate the benefits from the accident savings.
6. Assess the costs of fitting the new mirrors.
7. Determine the technical feasibility of retrofitting.
8. Assess the costs and benefits of retrofitting according to the scenarios in the ToR.
9. Undertake full sensitivity testing.

Countries were divided into the following groupings:

- **large:** the biggest countries in the EU25, where as much information as possible was sought;
- **medium:** the intermediate countries, where in some cases (e.g. Netherlands) there has been substantial research but otherwise such countries were only given special attention where information is available;
- **small:** the smallest countries, where factoring was typically applied to get to the overall total.

## 1.3 Report contents

The report starts with a review of the existing situation (chapter 2), first as regards the implementation of various EC directives and then regarding the fitting of mirrors to existing vehicles in those countries for which information is available.

The research and literature review (chapter 3) reviews material obtained by area, then in terms of the data needed to complete the cost benefit analysis, and finally by comparison with other evaluations carried out for the EC. Chapter 4 summarises the data collected in terms of the three main components of the evaluation spreadsheet i.e. vehicles (the market for retrofitting), casualties and the valuation of fatalities and injuries.

In chapter 5, the technical feasibility and costs of retrofitting are addressed. The cost benefit analysis is described in chapter 6 and includes the main results and sensitivity tests of the analysis. Chapter 7 contains further observations and general comments.

Appendix A shows the ToR, while Appendix B lists the persons contacted to date. Appendix C summarises the questions asked of representatives from the national ministries of transport/research organisations and vehicle/mirror manufacturers. Appendix D gives definitions of vehicle types and mirrors used in the report.



Appendix E summarises the structure of the evaluation spreadsheet, while Appendix F shows the questionnaire requesting information on the existing situation in each country. Appendix G shows accident costs researched in the UK, Germany and Netherlands.

## 2 REVIEW OF EXISTING SITUATION

### 2.1 Detailed composition of EC legislation and proposals

#### 2.1.1 Existing legislation

The current EC position has been periodically refined from Directive **71/127/EEC (Ref 6)**. The directive laid down requirements on how rear view mirrors should be fitted on vehicles and their construction.

The directive initiated a harmonised type-approval procedure for rear-view mirrors, so that each member state could check compliance with the common construction and testing requirements. The placing of an EEC type-approval mark on all mirrors manufactured in conformity with the approved type would remove the need for technical checks on these mirrors in other member states. However, the fitting of mirrors to different vehicle types remained discretionary.

Directive **79/795/EEC** made it more difficult for member states to authorise the entry into service of vehicles with rear view mirrors that did not have EEC type approval. It recommended to member states that exterior rear-view mirrors fitted on vehicles of categories M2, M3, N2 and N3 should be Class II mirrors, whereas those fitted on vehicles of categories M1 and N1 could be Class II or Class III mirrors.

All vehicles of categories M1 and N1 should be fitted with both an interior (Class I) and an exterior rear-view mirror. All vehicles in categories M2, M3, N2 and N3 should be fitted with two exterior rear-view mirrors, one on each side of the vehicle.

Under Directive **85/205/EEC (Ref 3)** member states were recommended to require:

- N3 articulated vehicles to be fitted with a 'wide-angle' (Class IV) mirror on the near-side;
- all N3 vehicles (rigid lorries with or without trailer and articulated tractor units) to be fitted with a 'close-proximity' (Class V) mirror.

Directive **86/562/EEC (Ref 4)** made minor amendments to allow the continued use of particular materials for the manufacture of Class I, II and III mirrors for so long as the requirements for the classes remained unchanged.

Directive **88/321/EEC (Ref 5)** required category N3 articulated vehicles to be fitted with 'wide angle' (Class IV) mirrors to each side of the vehicle; it also extended this requirement to all remaining category N3 vehicles and to category N2 vehicles exceeding 7.5 tonnes. The directive also extended the need for fitting 'close-proximity' (Class V) mirrors to category N2 vehicles exceeding 7.5 tonnes.

The latest directive, **Directive 97/2003/EC (Ref 117)**, was published in the OJEC (and therefore came into force) on 29 January 2004. The objective is to harmonise rules relating to type-approval of devices for indirect vision and vehicles equipped with these devices.

The main provisions are:

- The directive is mandatory for all new vehicles (unlike the current system which is discretionary for member states).

- Additional mirrors are required on certain vehicles in order to increase the driver's field of vision:
  - front (class VI) mirrors on goods vehicles over 7.5 tonnes,
  - exterior rear-view mirrors on the nearside of cars.
- Certain technical characteristics of mirrors have been modified in order to increase the field of vision, including an increase in the permitted protrusion from cars.
- Certain mirrors can be replaced by alternatives, such as camera/monitor systems.

All new category N2, N3, M2 and M3 vehicles must be fitted with such devices within 36 months of the directive coming into force; for class N1 and M1, the equivalent period is 72 months. The directive's proposals are summarised in Appendix D, together with diagrams comparing the fields of vision covered by the existing discretionary system with the compulsory requirements of the new directive.

As regards implementation, the directive states that:

- From 26 January 2005, member states cannot, on grounds relating to devices for indirect vision, either refuse EC type-approval, or prohibit the entry into service, of vehicles or devices for indirect vision, if they comply with the directive.
- From 26 January 2006, member states must refuse to grant EC type-approval or national type-approval for vehicles or devices for indirect vision (for all but Class VI mirrors), if they do not comply with the directive.
- From 26 January 2007, member states must refuse to grant EC type-approval or national type-approval for vehicles without VI mirrors, if they do not comply with the directive.
- From 26 January 2007, member states must prohibit the entry into service of category N2, N3, M2 and M3 vehicles, if they do not comply with the directive.
- From 26 January 2010, member states must prohibit the entry into service of category N1 and M1 vehicles, if they do not comply with the directive.

This applies to new members as well as EU15. For the purposes of this study, it is assumed to mean that by the end of 2006, all new vehicles (except N1) being entered into service will be fitted with the new systems. Preliminary responses from manufacturers suggest that the systems will only be fitted when it is compulsory (and therefore that few will be fitted before 2006).

## **2.2 Current and proposed situation in individual EU countries**

Different attitudes in various EU countries shown by the following examples:

### **2.2.1 UK**

The requirements for mirrors on motor vehicles which are to be used on UK roads are set out in full in regulation 33 of the *Road Vehicles (Construction & Use) Regulations 1986 (as amended)*<sup>#</sup>. Mirrors must comply with the requirements set out in:

- item 2 of Annex I to Community Directive 71/127: or 79/795;
- annex II to Community Directive 86/562 or 88/321; or

- paragraphs 4 to 8 of ECE Regulation 46.01, as appropriate.

The UK regulations specifically require all goods vehicles above 12 tonnes and registered in the UK since October 1988 to be fitted with a 'close proximity' (Class V) mirror. Articulated vehicles in this category must be fitted additionally with a Class IV 'wide angle' mirror on the nearside. This is in line with the requirements of Directive 85/205. Virtually all operational vehicles in this weight range are now fitted with these mirrors.

However, in the UK, not all provisions of Directive 88/321/EEC (Ref 5) have been implemented. For example, in the 7.5 -12 tonne range, the fitting of 'close proximity' (Class V) mirrors is optional and the compulsory fitting of 'wide angle' (Class IV) mirrors is limited.

The following tables summarise the existing vehicle requirements in the UK:

**Table 2-1 Mirror requirements – goods vehicles\***

Type of vehicle	Type of mirror			
	External (offside)	External (nearside)	Internal	Additional external
N1	yes	either external or internal		
N2	yes (Class II)	yes		
N3	yes (Class II)	yes		yes**

\* first registered after October 1998

\*\* 'close-proximity' (Class V) mirror required on the near-side. If the vehicle is articulated, it must also have a wide-angle (Class IV) mirror, also on the nearside.

**Table 2-2 Mirror requirements – buses\***

Type of vehicle	External (offside)	External (nearside)	Internal
M2 and M3	yes (Class II)	either external or internal	

\* first registered after October 1998

UK legislation does not require the fitting of mirrors to goods vehicles specifically to address the blind spot that lies directly under the front windscreen.

"Aside from the problems encountered by cyclists and motorcyclists; there is also a concern arising from left-hand drive HGVs visiting the UK. There have been a number of reported collisions, particularly on motorways, where the HGV driver has attempted an overtaking manoeuvre without noticing the presence of a car in the right hand lane. There is a strong possibility that such incidents could be avoided by fitting a close proximity mirror on the vehicle right hand side (the side opposite the driver)." (Ref 10)

As regards "close proximity" (Class IV) mirrors:

"An additional benefit of a close proximity mirror is that it is of use to HGV drivers driving on the 'wrong' side of the road (e.g. LHD vehicles driving in countries where driving is on the left and RHD vehicles driving in counties where driving is on the right). A number of accidents (or 'near misses') have been reported on motorways where continental HGV's have struck overtaking cars when moving to a right hand lane (Ref 10).

It should be noted that this is based on a different concept of the “blind spot” from that in Holland. In the above research, the “blind spot” is specified as being “caused by the passenger door on high vehicles”. In the Netherlands, the “blind spot” (“angle mort” in French) is defined as the area around a goods vehicle, coach or bus where an object, and in particular a cyclist, is invisible to the driver of a heavy vehicle. Each vehicle has a number of blind spots, to the front, the rear and the sides. These are shown on Figure D 1 to Figure D 8. The blind spot to the right of the vehicle is considered particularly dangerous for cyclists.

According to research undertaken for the UK Government:

“In the recent past, the lack of a clear view of the front of the vehicle has caused a number of fatalities when drivers have driven forward unaware that a child was crossing the road in front of the stationary vehicle. It has been estimated that elimination of this blind spot could save around 16 fatalities per year in the UK. This equates to about £16 million in benefits for a cost of £3 million.”

### **2.2.2 Netherlands**

In the Netherlands, the issue of collisions between HGV and cyclists is a very high profile one. The Netherlands has always complied fully with EC legislation (from Directive 71/127/EEC to Directive 88/321EEC) and much research has been carried out on the subject. As a result of this research, it was realised that these directives still left various blind spots to the driver’s vision, particularly on the right (passenger) side of the vehicle. Consequently, HGV drivers were offered a financial incentive to fit an additional “blind spot” mirror. The incentive scheme became operational in 2000. SWOV estimate that 25% of the Dutch HGVs were fitted with “blind spot” mirrors by the end of 2000. In 2001, this figure had increased to 35%.

New legislation was introduced in the Netherlands on January 1 2003 to improve blind spot coverage on the right hand side of the vehicle. The fitting of a blind spot mirror (or camera system) was made compulsory for HGVs (over 3.5 T GVW).

There are more than 20 approved systems which can be divided into five fundamentally different types:

- an external mirror mounted on the front of the vehicle (the DOBLI mirror);
- an internal mirror (the BDS);
- standard main and wide angle mirrors that rotate around the mounting pillar (the AVS system);
- an extra wide angle mirror (300mm) mounted on the pillar;
- a camera system meeting the required technical standards.

Buses and coaches are not seen to be such a problem. The statistics show few “blind spot” accidents between buses/coaches and cyclists. Moreover, those accidents that do occur tend to be less serious. Buses are of fundamentally different design to goods vehicles. With HGVs the driver can be completely unaware of a victim, even after the collision has taken place as the victim can often be dragged under this vehicle, and the driver will often not stop immediately, making the collision more serious. This seldom happens with buses/coaches, whose design effectively stops victims being dragged under the vehicle. Some urban buses are fitted with wide angle mirrors but this is decided by the operating companies. Mirror damage and replacement is a major cost for bus operators, reported to be the highest item of maintenance cost for some operators.

Figure 2-1 and Figure 2-2 show the trend in accidents between goods vehicles, buses and coaches, and small two-wheeled vehicles, from 1997 to 2003. Virtually all the accidents are understood to be with Dutch vehicles; transit vehicles are not significant. It is believed that the reduction over this period, particularly in fatalities in accidents with goods vehicles, has resulted, first, from the requirement for compulsory fitting of "blind spot" mirrors (or camera systems). The second factor is the increased awareness of the blind spot problem by truck drivers and vulnerable road users.

### **2.2.3 Belgium**

Belgium has similar concerns to the Netherlands. The problem is seen to be accidents between HGVs and cyclists, caused by the blind spot on the nearside of the vehicle. According to IBSR, in 2000, 23 cyclists were killed in accidents with goods vehicles turning to the right.

Statistics show there are few similar accidents between buses/coaches and cyclists. They acknowledge that there could be an accident risk immediately in front of the vehicle; however, they do not have the statistics to quantify the risk. The attitude in Belgium, as in Holland, is that reduction in casualties between cycles and HGVs is an important public concern. If the EU wishes to make Class VI mirrors compulsory, based on information available from other countries, they will support it.

Since early in 2002, improved mirrors have had to be fitted to public service vehicles. Between May 2002 and April 2003, there was a financial incentive for operators of HGVs of over 18T GVW to fit 'blind spot' mirrors. This amounted to €43.5 for each approved mirror. The approved mirrors were the same as in the Netherlands.

In anticipation of the new EC directive, Belgium has already tried to implement legislation to improve the situation in Belgium, prior to the new directive coming into force. From September 2002, based on the draft of the new directive, manufacturers were required to fit systems to new vehicles which were as close as possible to the new EU requirements.

Legislation implemented in December 2002 made it compulsory for one near-side Class IV wide angle mirror to be fitted to both N2 (less than 7.5T GVW) and M3 vehicles. Two Class IV mirrors must be fitted on N2 (over 7.5T) and N3 vehicles, even if the vehicle is not articulated. This applies to all N2 and N3 vehicles currently in service and to all new goods vehicles (N1, N2 and N3).

It is not known how many vehicles are fitted with these mirrors. This is because, in practice, operators have the option to comply with EC legislation, rather than Belgian, if they prefer to do so.

### **2.2.4 Germany**

We understand that Germany has also complied with EC directives on the fitting of mirrors but the number of accidents between HGVs and cyclists (in particular), and the possible reasons for this, is a live issue. A major conference was held in Berlin in April/May 2004 to discuss the matter.

The German Cyclists' Union has expressed concern that even when the new EC legislation is enacted:

- it will take until 2021 for all vehicles to be fitted;
- it will not apply to vehicles of 3.5T to 7.5T;
- the field of vision will not enable all victims to be identified.

They are therefore pressing the Ministry of Transport to introduce similar legislation to that in the Netherlands.

### **2.2.5 Italy**

According to the Italian Ministry of Transport, the differences between Italian legislation and the EU directives for existing vehicles is:

- nearside Class V close proximity mirror to be fitted to N2 vehicle (3.5 – 7.5 T GVW);
- only one nearside Class IV wide angle mirror required on N2 (over 7.5T) and N3 vehicles, even if the vehicle is articulated.

Research is undertaken in this area by private companies such as CRF (part of the FIAT Group dealing with advanced research and innovation). Iveco also undertakes accident studies.

### **2.2.6 Poland**

Vehicle fleet statistics from 1995 to 2002 were provided. There is limited disaggregation (e.g. by carrying capacity, trailers etc).

The only legal regulation on the subject would seem to be that of the Ministry of Infrastructure, of December 2002 relating to the technical condition of vehicles and obligatory equipment. This simply requires vehicles to have at least two external mirrors, one on each side, where the internal mirror does not provide adequate visibility.

As regards accident statistics, most are available by voivodship (region). The police do gather detailed information on accidents but this is given to the voivodships and there is no computer system readily available to extract detailed breakdowns. Data which can be extracted, does not include accidents by vehicle type involved.

### **2.2.7 Denmark**

In 1988, as part of the Danish Road Safety Action Plan, a new law was passed that prescribed all Danish lorries above 6,000 kg to carry two extra external right mirrors: a close proximity and a wide-angle mirror. It was anticipated that the implementation of the measure would result in a 50% drop in right turning vehicle accidents being either fatal or serious.

A “before and after” study was conducted to evaluate this target covering the period 1984 to 1991. It looked specifically at accidents involving right-turning lorries compared with all other accidents involving two-wheelers and lorries. The study found no significant safety effect of the additional mirrors other than a modest decrease in fatal incidents, and concluded that the target of a 50% accident reduction was overly optimistic in the given timeframe. The unsupportive results have been somewhat accounted for by the fact that two thirds of all drivers questioned in the study did not take full advantage of the mirrors. Furthermore, police reports covering the same period in question showed that, in many cases, the cyclist or moped rider had been outside the areas that the mirrors were to suppose to cover, according to the law.

In response to the above study the Danish Road Safety Council launched a campaign in 1992 to make drivers more aware of the potential benefits of additional mirrors. Unfortunately roadside interviews conducted by the Danish Road Traffic Police

conducted in a similar before and after study as above, showed no discernible effect of the campaign. However, among the 17% of the lorry drivers who had seen and used the leaflet, 65-70% had at least one of the extra mirrors correctly adjusted after the campaign.

Recommendations of the all the studies undertaken suggested that drivers still needed to be trained in the correct use of their mirrors. Launching campaigns in making two-wheelers more aware of lorries that are about to turn right was thought also to be beneficial.

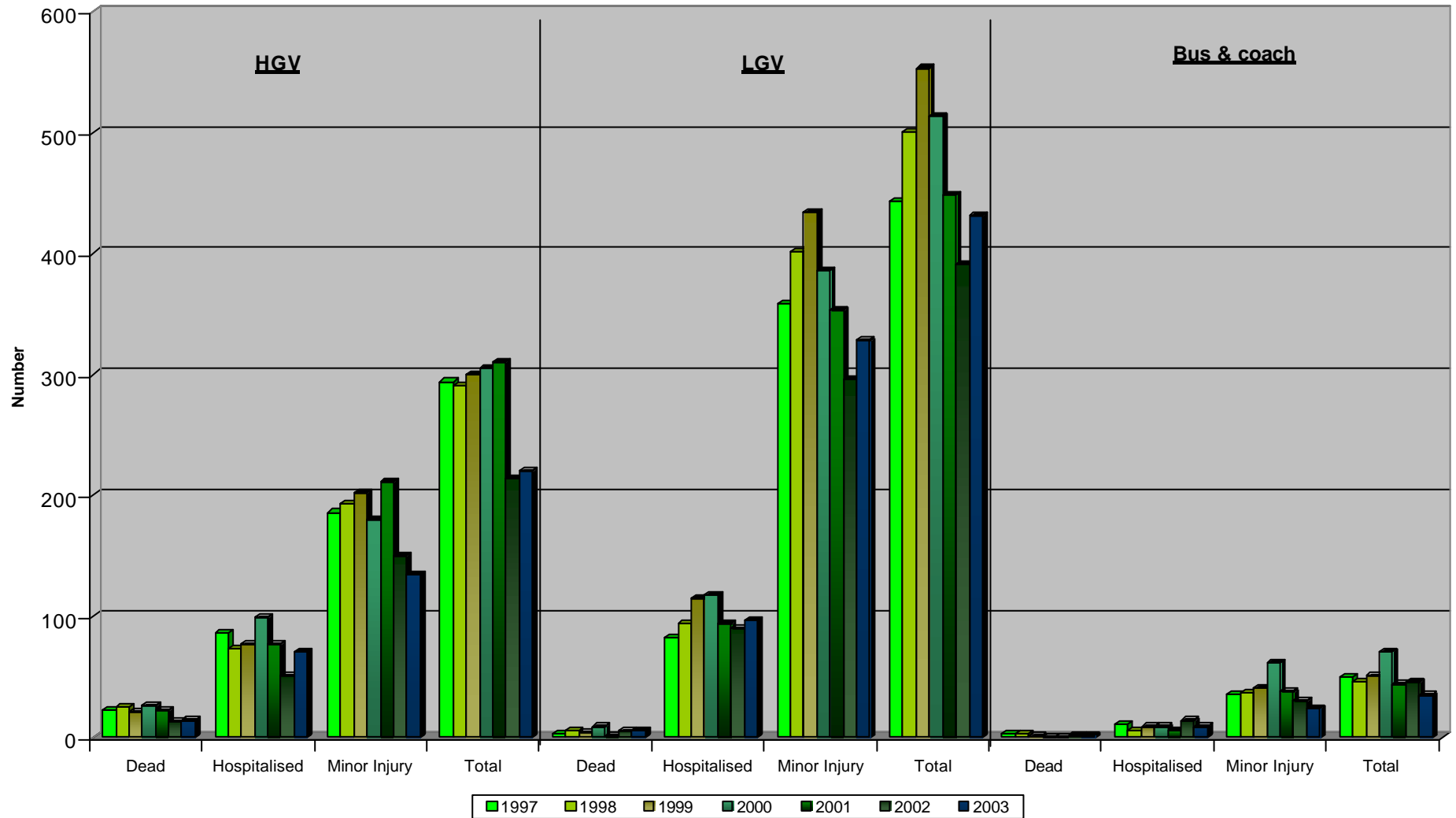
Despite the foregoing, it is understood that legislation is being introduced so that, from October 2004, all lorries over 3.5T must be fitted with a mirror or camera system providing improved visibility on the nearside of the vehicle. This again seems to be broadly similar to the Dutch system.

### **2.2.8 Finland**

In Finland, both vehicles and their mirrors are required to fulfil Directive 71/127/EEC (**Ref 6**), as last amended by Directive 88/321/EEC. No relevant research appears to have been undertaken in Finland on this topic. Neither are there suitable statistics on accidents between goods vehicles and small two-wheelers.

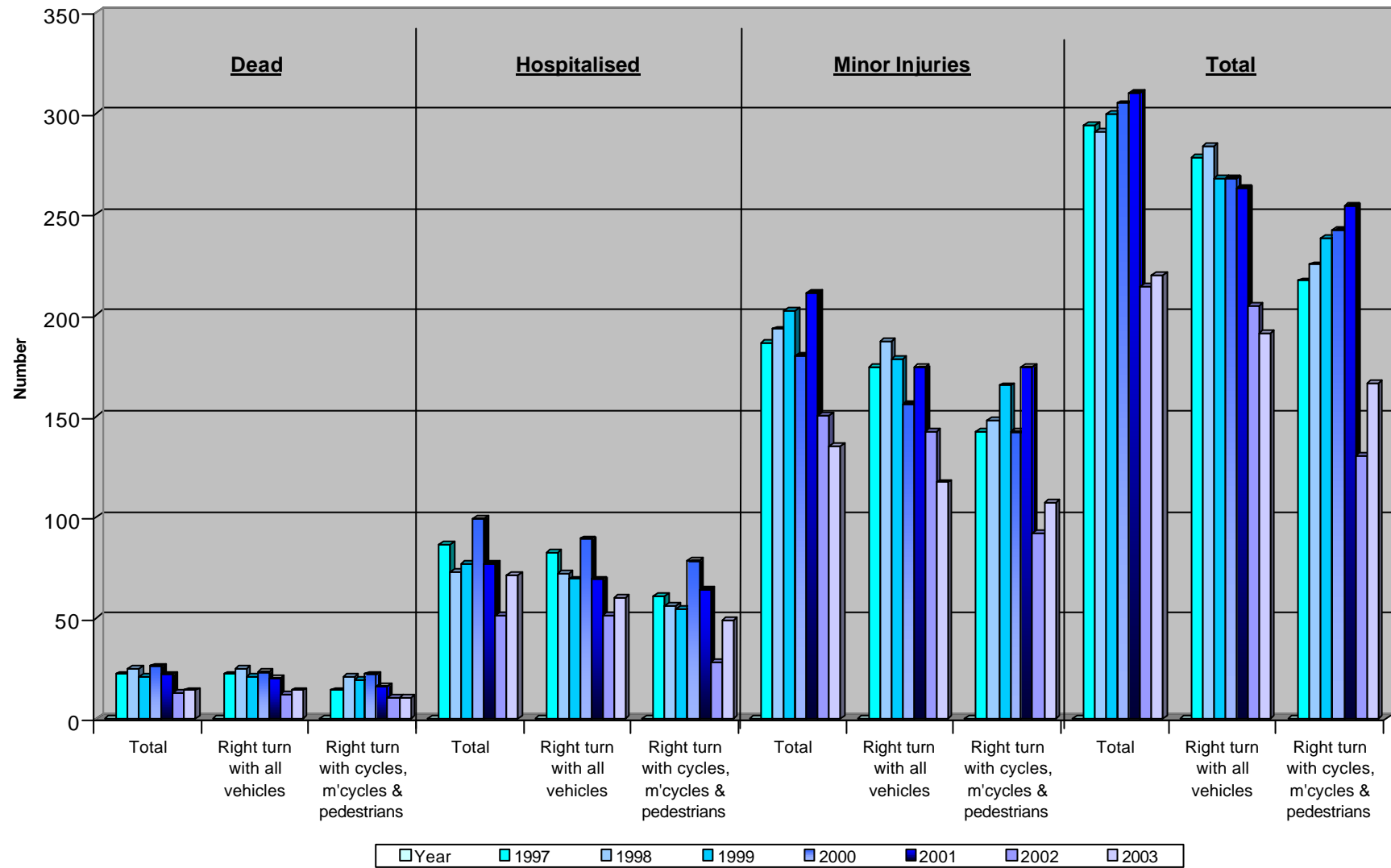


Figure 2-1 Goods vehicle, bus and coach accidents in the Netherlands, 1997-2003



Source:(Ref 124)

Figure 2-2 Breakdown of HGV accidents in the Netherlands, 1997-2003



Source: (Ref 124)

## 3 RESEARCH AND LITERATURE REVIEW

### 3.1 UK

#### 3.1.1 Driver's Field of View from Large Vehicles (ICE Ergonomics, 1999)(Ref 81)

##### (a) Purpose of study

This project examined various aspects of the driver's field of view for HGVs (N2 and N3) and buses and coaches (M1 and M2). Relevant accident data was analysed to identify the extent to which the driver's vision was a contributory factor to the accident. Then to ascertain the physical causes of ineffective vision, a modelling and reconstruction technique was adopted. This method was also used as the means to assess potential field of view improvement strategies and to generate graphic representations of the results.

##### (b) Work carried out

The project concluded that the most cost-effective means for improvement to the driver's field of vision entailed a combination of additional, modified and repositioned mirrors as follows:

- one mirror mounted internally on the near-side A-pillar to view the immediate front of the vehicle;
- an additional wide angle mirror on the off-side;
- a near-side, wide angle mirror fitted to all large vehicles except articulated vehicle tractor units, which already have one fitted.

By vehicle type, these equate to the following:

#### Rigid HGVs

- reduce the Class II mirror's convex radius of curvature to 1200mm (currently 1800mm);
- fit Class IV mirrors below the near-side and off-side Class II mirrors (currently a Class IV mirror is only required on the near-side of N3 articulated tractors);
- fit a near-side Class V mirror (currently a Class IV mirror is only required on the near-side of N3 articulated tractors);
- fit a Class VI mirror.

#### Articulated HGVs

- reduce the Class II mirror's convex radius of curvature to 1200mm (currently 1800mm);
- fit an additional Class IV below the off-side Class II mirror;
- fit a Class VI mirror.

#### Buses and coaches

- reduce the Class II mirror's convex radius of curvature to 1200mm (currently 1800mm);
- fit Class IV mirrors below the near-side and off-side Class II mirrors;

- fit a Class VI mirror.

The proposed mirrors as fitted to a continental European vehicle are shown diagrammatically on

Figure 3-1. These are viewed from inside the driver's cab.

The nearside mirrors would need to be remotely adjustable from the driver's seat. Also, it was proposed that to fully cover the field of view requirement, a CCTV system would need to be fitted to cover the blind area immediately behind all large vehicles when reversing.

For buses and coaches, it was proposed that a two-camera CCTV system should be introduced. One camera would be mounted directly behind the vehicle and a second would be housed in the near-side mirror.

A cost /benefit analysis was carried out, first by estimating the cost of implementing the proposed field of view improvement to new vehicles. This implementation cost was then divided by the cost of prevention of a fatal casualty so that the resultant value gives a figure for the number of fatal casualties that would have to be saved as a result of the implementation to recoup the cost. Finally, other sources were examined to determine the likelihood of achieving the necessary reduction in fatal accidents.

The estimated costs of fitting the devices were as follows.

• additional mirror	£30 (€45)
• additional cost to make electrically adjustable	£20 (€30)
• CCTV system (camera and monitor)	£150 (€225)
• additional camera	£50 (€75).

The number of vehicles first licensed in 1997 was:

• articulated trucks	13,200
• rigid trucks	22,000
• trailer stock	120,000
• buses and coaches	6,600.

The average value per fatality was estimated at £900,000 (€ 1.35 million), based on DETR-RAGB97 – 'Average value of prevention per casualty'.

### (c) Conclusions

#### **Additional mirrors (with driver adjustment)**

The recommendations were for three additional mirrors for rigid large vehicles and two for articulated tractor units. The cost of fitting additional standard mirrors to the new HGV fleet was estimated at £2.8 million (€4.2 million). The additional cost of converting to remotely adjustable near-side mirrors was estimated at £1.4 million (€2.1 million). Coverage of the implementation cost of such mirrors would require the saving of 5 fatalities.

#### **CCTV reversing aids for HGVs**

The cost of fitting CCTV to the new HGV fleet was estimated at £5.3 million (€7.9 million). Coverage of the implementation cost of the CCTV would require the saving of 6 fatalities.

### **CCTV for buses and coaches**

Implementation of the CCTV system for buses and coaches would cost £1.5 million (€2.2 million). Coverage of the implementation cost of the CCTV would require the saving of 6 fatalities.

To cover the cost of implementing the full range of recommendations, 13 fatalities per year would need to be saved. In a detailed study by the TRL (Robinson 1997) of 1049 fatal accidents, causing 1194 fatalities, between 1991 and 1993, and involving at least one HGV, it was concluded that two of the most common accident scenarios also involving vulnerable road users were:

- HGV drivers failing to see cyclists or motorcyclists as they enter a major road or roundabout;
- pedestrians attempting to cross the road directly in front of a stationary HGV, which strikes them as the driver pulls away.

The report went on to state that the estimated annual savings from improved forward vision from HGV cabs through lowering the windscreen's lower edge would approximate to 10 lives saved per year. If buses and coaches were included, the expected saving would increase.

In 1997, analysis of large vehicle accidents showed:

- 1144 where the manoeuvre prior to the accident was recorded as changing lane;
- 971 where the manoeuvre was described as overtaking a moving or stationary vehicle;
- 258 recorded as reversing prior to the accident.

All of these manoeuvres require the vehicle's driver to check areas where the proposed near-side and off-side mirrors and CCTV will improve their field of view. Of the 2373 accidents recorded as occurring during these manoeuvres, ICE Ergonomics considered it reasonable to assume a similar fatal casualty saving of about 10 lives, as claimed for improved frontal vision, for improved near-side, off-side and rear vision.

They claimed that this could be supported by the results of a further study on reversing accidents in UK transport fleets (Murray et al, 1997), where it was reported by a reversing safety equipment manufacturer that on-road accidents account for less than 10% of the total number of reversing accidents reported in RAGB (Hanson- Abbot, 1997). If a further 5 off-road reversing fatalities were saved as a result of fitting CCTVs then a total fatal casualty saving of 30 lives a year would seem a feasible and conservative estimate.

In Figure 3-2, the cost/benefit graph shows the cost of introducing the proposed field of view improvement strategy to the whole UK large vehicle fleet. It assumes a 10% new large vehicle replacement a year. Hence the cost of implementation remains constant while the benefit (savings in cost of fatal casualties) rises by 10% a year until a maximum estimated casualty cost saving is reached when the entire large vehicle fleet is equipped.

It can be seen that the net savings from the universal implementation of the additional wide angle mirrors, the electrically adjusted Class II mirrors and the CCTV systems starts a little after 8 years, and after 10 years becomes £5.2m per year.

On the basis of this analysis, ICE Ergonomics concluded that to achieve saving of 13 fatalities per year through the implementation of their full range of recommendations was realistic.

**(d) TRL (Ref 10)**

Research has been commissioned by the DfT (**Ref 10**) (contracted to TRL) to

- assess the casualty reduction potential of compulsory fitting close proximity (Class V) “blind spot” mirrors to heavy goods vehicles not already covered by current requirements (eg UK registered vehicles between 7.5 tonnes and 12 tonnes, and visiting EU registered vehicles over 7.5 tonnes);
- prepare a regulatory impact assessment concerning the Commission proposal on retrofitting “blind spot” mirrors.

According to the ToR for this study:

“Although collisions between HGVs and cyclists or motorcyclists are not particularly common, when such collisions do occur, a high proportion result in severe or fatal injury. In 2001 there were 1005 recorded collisions between HGVs and two-wheeled vehicles, of which 58 resulted in fatal injury and 239 resulted in serious injury to the cyclist/motorcyclist. Many of these accidents may be due to the inability of the HGV driver to be aware of traffic close to the side of the vehicle, particularly in the ‘blind spot’ caused by the passenger door on high vehicles.” (**Ref 10**)

**(e) Cost Benefit Analysis of Road Safety Improvements (Ref 30),**

The study for DGTREN, “Cost Benefit Analysis of Road Safety Improvements” by consultants ICF (**Ref 30**), provided a breakdown of costs for crashes and casualties. The principal source was a paper from the TRL in the UK of 1995. The original costs in 1994 UK pounds were converted to 2002 euros by multiplying by 1.54 for the euro to pound exchange rate and by 1.27 for 8 years’ inflation at 3% per year.

The report makes the following comments on the cost items:

- Lost output comprises the loss to the economy resulting from the lost working time of the crash victim. This includes lost earnings by the victim(s) as well as other losses to the economy at large.
- The human cost is the value placed on a fatality or injury, separate from identifiable economic losses. The term “human cost” is assumed to be equivalent to the value of a life and is usually estimated by analysing how much people are willing to pay to reduce the risk of becoming a crash victim.
- Property damage includes the cost of damage to all involved road vehicles, the cost of a replacement vehicle, where required, and damage to other property.?
- Police costs are based on actual surveys of police activity related to crashes, including administrative duties as well as attendance at the crash scene.
- Insurance costs are not counted as a crash cost. The costs of a crash are assumed to be independent of whether any of the costs can be reimbursed to the injured parties by insurance. An administrative cost for insurance is included, as an insurance claim will trigger costs for assessing damage and processing the claim.

The original costs were derived per crash. In order to convert from to costs per fatality and per injury were based on:

- 1.36 injuries per injury-causing crash;
- 1.15 fatalities per fatal crash.

The largest individual cost is the human cost. ICF undertook a review of multiple studies, which yielded a range of estimates between €0.5 million and €3 million. DGTREN specified in their ToR that a value of €1 million should be used for the human value of a fatality, which is at the lower end of the range, but close to the value calculated from the original UK TRL study

### 3.1.2 Netherlands

#### (a) Improvement of the Vision of Drivers of Trucks and Vans (TNO, 1998) (Ref 59)

The analysis related to cycles and mopeds, HGVs (>3.5T) and LGVs (<3.5T). Accidents involving cycle and moped occupants were analysed as shown in the following tables:

**Table 3-1 Fatal accidents involving cycle and moped occupants, 1996**

Victims	Total	Accidents involving goods vehicles	Proportion involving goods vehicles
Killed	1 180	256	21.6%
Of which, cycle and moped occupants	340	100 (37 LGVs and 63 HGVs)	29.4% (10.8% LGVs and 18.5% HGVs)
Proportion	28.8%	39.0%	

**Table 3-2 Serious accidents involving cycle and moped occupants, 1996**

Victims	Total	Accidents involving goods vehicles	Proportion involving goods vehicles
Seriously injured	11966	1274	10.6%
Of which, cycle and moped occupants	4732	467 (305 LGVs and 162 HGVs)	9.8% (6.4% LGVs and 3.4% HGVs)
Proportion	39.5%	36.6%	

The proportion of fatalities involving goods vehicles is 29.4%, whereas the proportion of goods vehicles in the total vehicle fleet is only 9.7%.

The distribution of the 63 fatalities from Table 3-1 is shown on Figure 3-3. Some 36% of fatalities are in “blind spot” accidents, defined as goods vehicles turning right and cycles/mopeds going straight ahead. As shown in Figure 3-4, some 68% of “blind spot” collisions are with trucks (and 7% with vans), compared with a maximum of 44% in other manoeuvres.

To determine the potential accident saving, it was assumed that the difference between the accident rates for trucks and non-goods vehicles resulted from differences in the field of vision. If improved mirrors were fitted to give the same field of vision to goods vehicles as cars, then their accident rates would be similar.

In 1996, there were 36 fatalities in “blind spot” accidents, of which 68% involved trucks (equivalent to 24 victims). The rate for non-goods vehicles is 25% (5 victims). The saving is therefore 43% of “blind spot” fatalities (15 fatalities per year), equivalent to:

- 15 % of cycle/moped victims in crashes with vans/trucks;
- 4.4% of total cycle/moped victims;
- 1.3% of all fatalities.

**(b) Systems for Improving Fields of Vision for Trucks (TNO, 1999) (Ref 60)**

When the Dutch Government announced its intention to legislate on the introduction of “blind spot” mirrors, various types of vision device were put forward to cover the “blind spot”. Field tests were undertaken to compare the devices in terms of the percentage of objects in the “blind spot” detected by the different systems. The results are shown in Figure 3-5. For the basic mirror, the percentage not detected decreased from 44% to 7%, a saving of more than 80%. In the case of the camera system, the reduction was also more than 80%.

**(c) Analysis of Police Reports relating to Field of Vision and Location of Victim (TNO, January 2001) (Ref 61)**

In order to confirm that in reality the new “blind spot” vision devices would be picking up their targets, police records were analysed showing the actual locations of victims. The areas used for analysis are shown on Figure 3-6. The results presented in Table 3-3 show that most of the victims are to the rear of the driver’s position, up to 2.5 metres out from the cab. It should, however, be remembered that these come from a valid sample of only 10.

**Table 3-3 Location of victims in “blind spot” accidents**

Area	Per cent
2	5.3%
2 and 5	5.3%
1 and 2	5.3%
3 and 4	5.3%
2, 3 and 4	5.3%
3, 4 and 5	5.3%
1	10.5%
1 and 5	10.5%
4 and 6	10.5%
5 and 6	36.8%
Total	100.0%

Source: TNO, January 2001 (refer to Figure 3-6 for locations)

**(d) Fields of Vision related Victims among Small Two-wheeled Vehicles: a European Perspective (TNO, November 2001) (Ref 9)**

The analysis carried out in the Netherlands to identify the presence of trucks in collisions with cycles and mopeds was extended to other countries in Europe. The most useful data was obtained for Belgium, Germany, the UK, Sweden and Ireland; the results are summarised in Figure 3-7.

The Netherlands and Belgium have the highest share of small two-wheeled vehicles in total casualties. However, the percentage of goods vehicles in cycle/moped collisions shows little difference between countries, except for Sweden, which is significantly lower than the others. By this measure, Germany and Ireland are above Holland and Belgium.



**(e) Cost Benefit Analysis of Measures to Improve Goods Vehicle Safety (Draft Report SWOV, January 2004) (Ref 80)**

SWOV are undertaking a comparative review of the costs and benefits of various measures to improve goods vehicle safety, including retrofitting of blind spot mirrors and cameras. Their base year is 2001, when they estimate that 35% vehicles were already fitted with mirrors (none with cameras), leaving 65% of the fleet not equipped.

Recently the European Transport Safety Council (ETSC **(Ref 44)**) has published a review of 'promising' EU safety measures for all transport modes. Researchers from two Rosebud institutes (Rune Elvik (TOI), Paul Wesemann and Chris Schoon (SWOV)) contributed to a cost-benefit analysis of 5 road safety measures.

The goal was to identify a series of cost-effective measures, which, if applied, could give a substantial contribution to reaching the ambitious EU target of halving road deaths by the year 2010.

The costs of a measure are understood as the social costs of all means of production (labour and capital) that are employed to implement the measure; therefore they are called implementation costs. The effects of a measure are understood as any change in social welfare (positive or negative) that is the result of that measure (intended or not). The aim of a measure is to decrease the damage caused by road accidents, which means that the effects to take into account first are the safety effects.

All costs and effects are valued at the price level 2000 and exclude VAT; price data from previous years are corrected for an inflation-rate of 1.7 % per year. Future effects and implementation costs (e.g. maintenance and additional fuel costs) are discounted against a rate of 5% per year (EC, 2002). Furthermore, the mirrors were assumed to have a lifespan of 10 years and be 40% effective throughout the period.

The safety effects have been expressed in the number of fatalities while environmental effects have been stated as a certain proportion of the total costs of pollution by road transport in the relevant EU-countries (CEC, 1995).

### **3.2 Germany**

**(a) Right turning Vehicle Accidents in Berlin, Berlin Police (Ref 132)**

According to a research study conducted by Hansjoerg reader, and Olav Mueller (**Ref 132**), in Berlin each year approximately 20 cyclists die in traffic accidents. More than half of these were accidents involving right turning trucks colliding with cyclists. Based on this analysis the writers have predicted that annually there are approximately 200 fatal accidents in Germany between right turning trucks and cyclists. A common denominator of these incidents is the safety weak points still found on many modern trucks, particularly the view from and the protection provided by the side rollovers of trucks.

The research study also examined 141 separate cases (Table 3-4) of recorded accidents in Berlin. The results suggested that approximately 90% involved cyclists and that 56% of these resulted in serious or fatal injuries predominantly caused by heavy goods vehicles.

**Table 3-4 Accident victims and proportion of fatal accidents by vehicle type (Berlin)**

Type of Accident	Number of victims
Bus-cyclists	2
Truck-cyclists	125
Bus-Pedestrian	2
Truck-Pedestrian	12
<b>Total</b>	<b>141</b>
Portion of deadly accidents by vehicle type	
HGV	34%
Articulated HGV	13%
Bus	4%
Semi-trailer and truck	18%
Vehicle<7.5t	16%
Vehicle<3.5t	15%
<b>Total</b>	<b>100%</b>

Source: (Ref 132)

Measures have been taken to increase the safety aspect of right turning trucks and lorries, mainly by improving the weak points mentioned above. Though roll over devices have become commonplace in Germany, they have little incentive in preventing accidents even if they reduce the severity of the accident. A more important consideration held by the writers was the driver's field of vision. Their research suggested that over 40% of accidents happen on the right front and rear sections of trucks where visibility was the poorest. Mirrors contributed significantly towards what surroundings drivers were aware of, especially when turning right.

The study also concluded that whatever the driver's view from the truck, even with additional mirrors and or video cameras. Safety relied extensively on the driver being able to use the equipment properly. Failing to do so potentially could hinder the driver and lead to accidents.

**(b) "Blind spot" Accidents in the German State of North Rhineland Westfalen (Ref 130)**

This report refers to accidents between commercial vehicles and pedestrians/cyclists, for 2002, in a single German state. This revealed a total of 1069 accidents, of which there were:

- 42 deaths
- 246 seriously injured
- 699 slight injuries (not hospitalised)

There were 68 incidents of trucks turning right, colliding with cyclists and pedestrians, of which there were:

- 2 deaths
- 16 seriously injured
- 50 slight injuries

All the accidents occurred in urban areas, mostly in the morning between 07.00 and 08.00, and from midday to 14.00.

**(c) Incidents with Right Turning Vehicles in Berlin (Ref 132)**

The total number of casualties in accidents with motorised vehicles turning right in Berlin, according to police records, was as follows:

Year	Total	Cyclists	Pedestrians	Cycle deaths	Pedestrian deaths
2000	503	342	62	3	3
2001	515	345	76	3	3
2002	519	367	59	4	3
2003	510	368	57	8	6

The equivalent figures, but just for goods vehicles, are:

Year	Total	Cyclists	Pedestrians	Cycle deaths	Pedestrian deaths
2000	95	73	7	3	3
2001	83	68	6	2	2
2002	103	66	4	2	2
2003	97	75	5	7	6

Particular conclusions to be drawn from these figures are that:

- the vast majority of the fatalities are with goods vehicles;
- unlike most other time series for accidents, the figures have remained reasonably constant, rather than declining.

**3.3 United States**

**3.3.1 Documents reviewed**

The principal US documents reviewed are shown in the following table.

**Table 3-5 U.S documents reviewed**

Ref no	Document	Author	Year	Comments
26	US Large Truck crash facts	FMCSA	2001	Statistics on reasons for crashes
32	Motor Vehicle Safety Standard No. 111; Rearview mirrors	FMCSA		Legal position of mirror fitting and mounting
33	Article on rear mirrors in 'Drivers' March 7 2001	The National Private Truckers Council (NPTC) (2001)	2001	Suggest flexible arrangement for mirror fitting
34	Rear cross-view mirror performance: Perception and optical measurements Final Report	NHTSA	1998	Technical report on the performance of different mirrors
35	Non-planar drivers side rearview mirrors Final Report	NHTSA	2000	Comparison of US and EU mirrors but on drivers side (not nearside)
36	Requests for comments on new rear side technology and Federal Motor vehicle safety standard No. 111	NHTSA	2003	
38	Efforts to Reduce Mirror Blind Spots	The Chronicle of ADTSEA	1997	Discussion of issues on mirror design in US
40	Identifying unsafe driver actions that lead to fatal car-truck crashes	AAA Foundation for Traffic Safety	2002	Analysis of driver related factors
41	Longer Combination vehicle safety data collection	AAA Foundation for Traffic Safety	2000	Recommendations on methods of collecting accident data
42	2001 large truck crash overview	FMCSA	2002	Basic statistics – No detailed breakdown
43	Improved visibility for operating large haulage equipment	Michigan Mine Safety & Health Training	1996	Truck safety in mines and quarries (oversize trucks)
49	Lighting, signalling and rear view mirrors for large trucks: A review of human factors considerations	University of Michigan, Transportation Research Institute	2002	Technical issues focusing largely on lighting and signal effectiveness
50	Geometric visibility of mirror-mounted turn signals	University of Michigan, Transportation Research Institute	2003	Signal visibility
63	Mirror field of view in light trucks, minivans, and sport utility vehicles	University of Michigan, Transportation Research Institute	2001	Visibility of mirrors (technical)
65	Missouri state highway system traffic accident statistics	Missouri Department of Transportation	2002	Numbers of accidents against description of cause
69	Distractions in everyday driving	AAA Foundation	2003	Role of distraction in accident causation
70	Drivers most at risk from distractions outside car	Drivers.com	2001	Further analysis of driver distraction

### 3.3.2 Main observations

Much of the US literature review reveals topics on the periphery of interest to the current study. The discussions tend to be of technical rather than economic issues. Mirror convexity seems to be a current key convexity in the US where historically only flat mirrors have been permissible. There is considerable recent research on driver behaviour and particularly inattention as a cause of accidents. There is also debate on the appropriateness of a single defined mirror standard for the wide range of shapes and sizes of trucks on the market.

### 3.3.3 Points of possible interest

US legislation governing rear view mirrors and rear visibility systems is contained within Federal Motor Vehicle Safety Standard No. 111.

In **Ref 33**, The National Private Truckers Council (NPTC) argues that a single rule for rear view mirrors or visibility systems would not be applicable given the vast array of equipment and operating conditions and the speed with which truck technology is changing. The group believes the best way to make improvements in this area is to allow individual fleet operators to choose the equipment or other countermeasures that make the most sense for their vehicles and fleet operations.

For example, while cross-view mirrors may be appropriate for some trucks in that weight range, there are many others with body configurations that inhibit their use. In some instances the design of the vehicle may prevent installation altogether. In other cases, the mirrors would be damaged in use at certain loading docks, such as those employing bumper cushions or weather seals.

NPTC claim that members who have employed other rear-view technologies, such as sonar devices and video cameras, report that the benefits of these are also dependent in large part on equipment and operational conditions. Some sonar devices are found to work improperly in cold and wet climates. The sonar fields are distorted creating false signals. Video devices likewise can sometimes produce distorted views, especially under certain weather and equipment operating conditions.

The NPTC believes each type of unit and operational use must be evaluated to determine the best available option for rear view devices. Also, any standard promulgated by the agency, whether intentionally or not, could have the affect of requiring the use of devices that may be inappropriate to a particular vehicle or use.

**Ref 26** suggests that only 0.1% of fatal crashes involving large trucks (more than 4.5 tonnes) were due to vision being obscured by obstructing angles on a vehicle.

In 2003 NHTSA were considering petitions to allow convex mirrors on the passenger side of trucks exceeding 4.5 tonnes. At present only flat mirrors can be used on all heavy vehicles. The NHTSA's position historically has been that an object viewed in a convex mirror is both smaller and distorted than that of the same object viewed in a flat mirror; therefore, such an object appears farther away. In addition whereas the convex mirror achieves greater field of view it cannot give precise depth and speed perception. Other problems associated with the use of convex mirrors include double vision, eyestrain and nausea.

### 3.3.4 Japan

In order to address to the growing motor vehicle dependency in recent years in Japan, the country decided in November 1998 to become a fully-fledged member to the "The UN/ECE 1958 Agreement" on Reciprocal Recognition of Type Approval of Motor Vehicles, etc. This Agreement was designed to develop global regulations for all types of road-based vehicles.

At present, over 110 ECE Regulations have been established. Prior to Japan's full commitment only 11 of these regulations had so far been adopted in the country. One of those few regulations to be recognised was the introduction and installation of Class IV mirrors to all new trucks to improve driver spatial awareness. Class VI mirrors to

ensure front visibility were also encouraged but made optional in conjunction with training schemes for drivers and the general public.

Figure 3-8 demonstrates the effect of these regulatory improvements to driver vision in comparison to total accident fatalities in Japan, which are recorded on a monthly basis by the National Police Agency. Starting with a base year of 1976 the number of fatal accidents caused by left-turning vehicles dropped dramatically over a period of 8 years, as regulations were introduced and enforcement commenced. In contrast, total fatal accidents remained relatively constant, implying that other traffic related accidents must have either risen or stayed constant to compensate the fall in left-turn fatal accidents.

Figure 3-1 Proposed mirror layout on Continental European vehicles, viewed from inside driver cab (diagrammatic only)

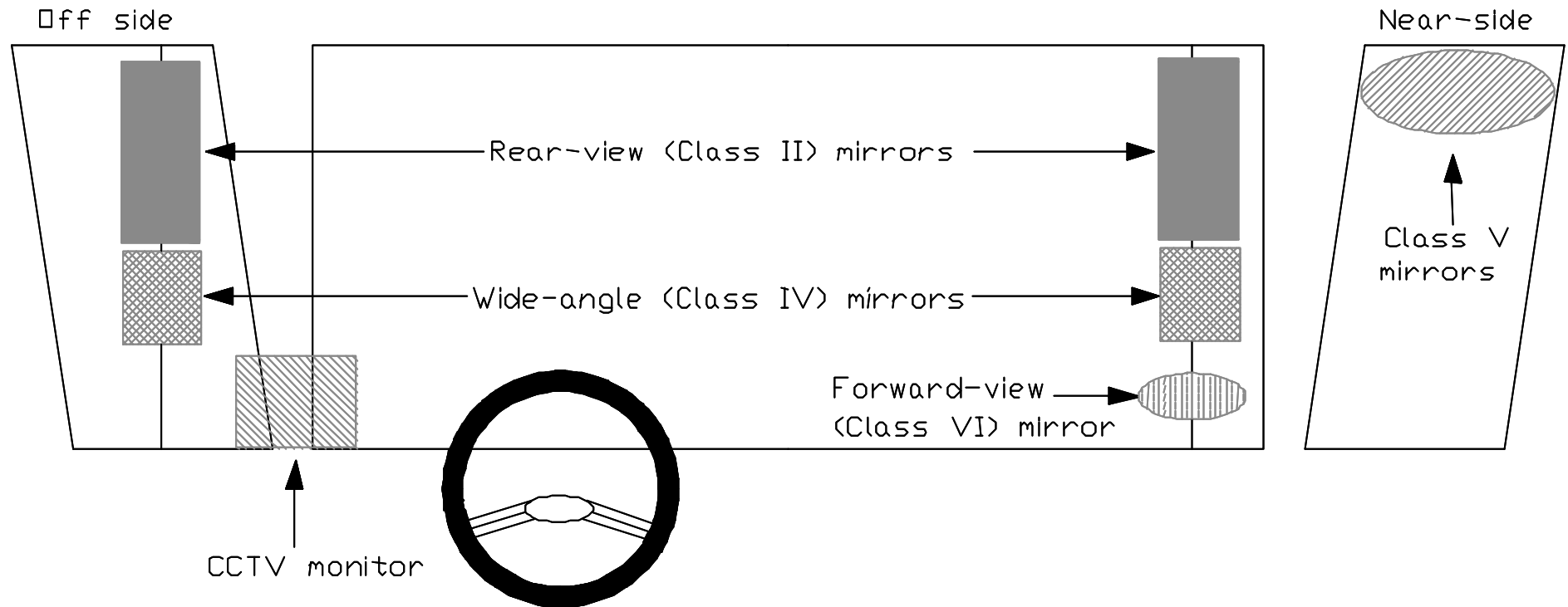
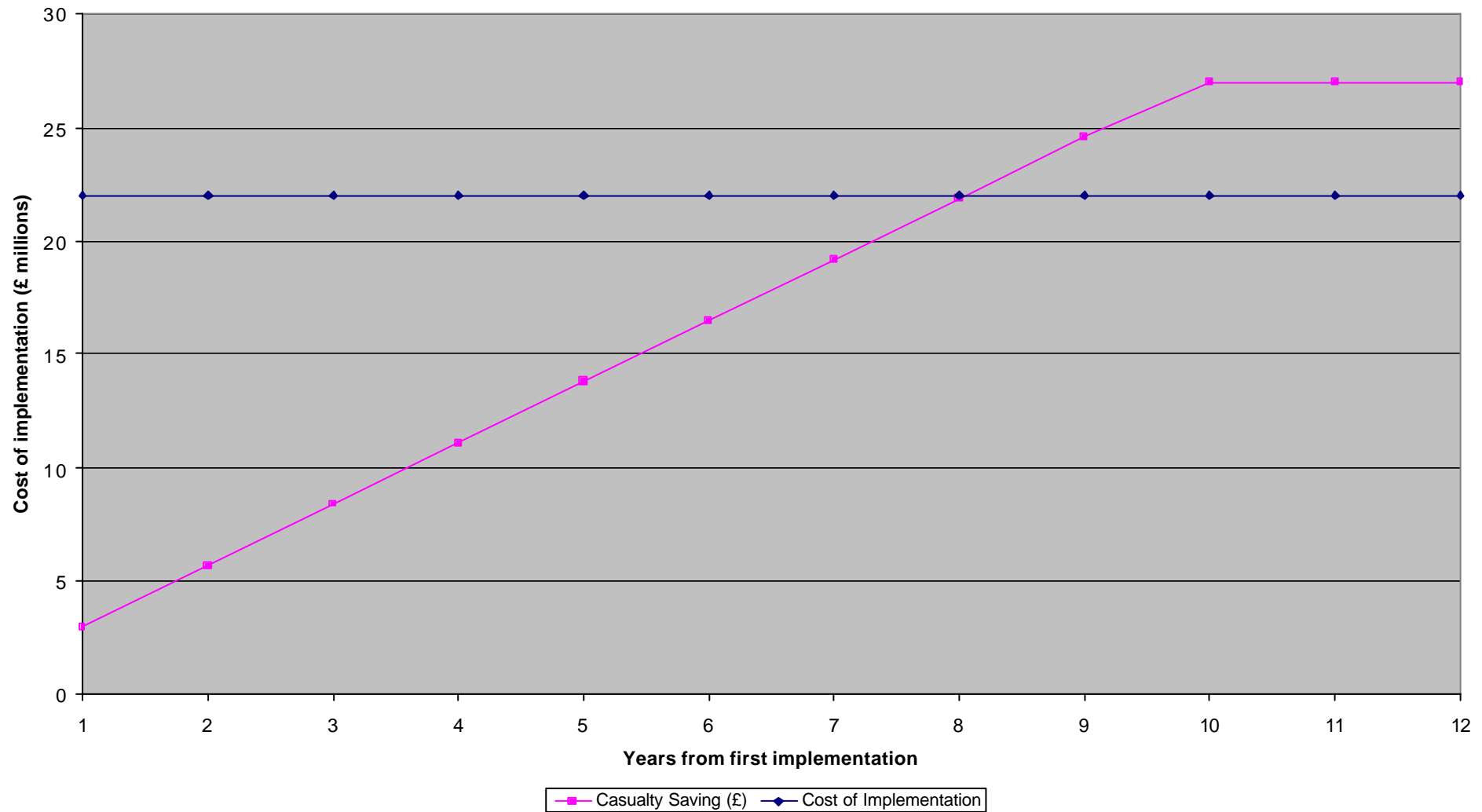


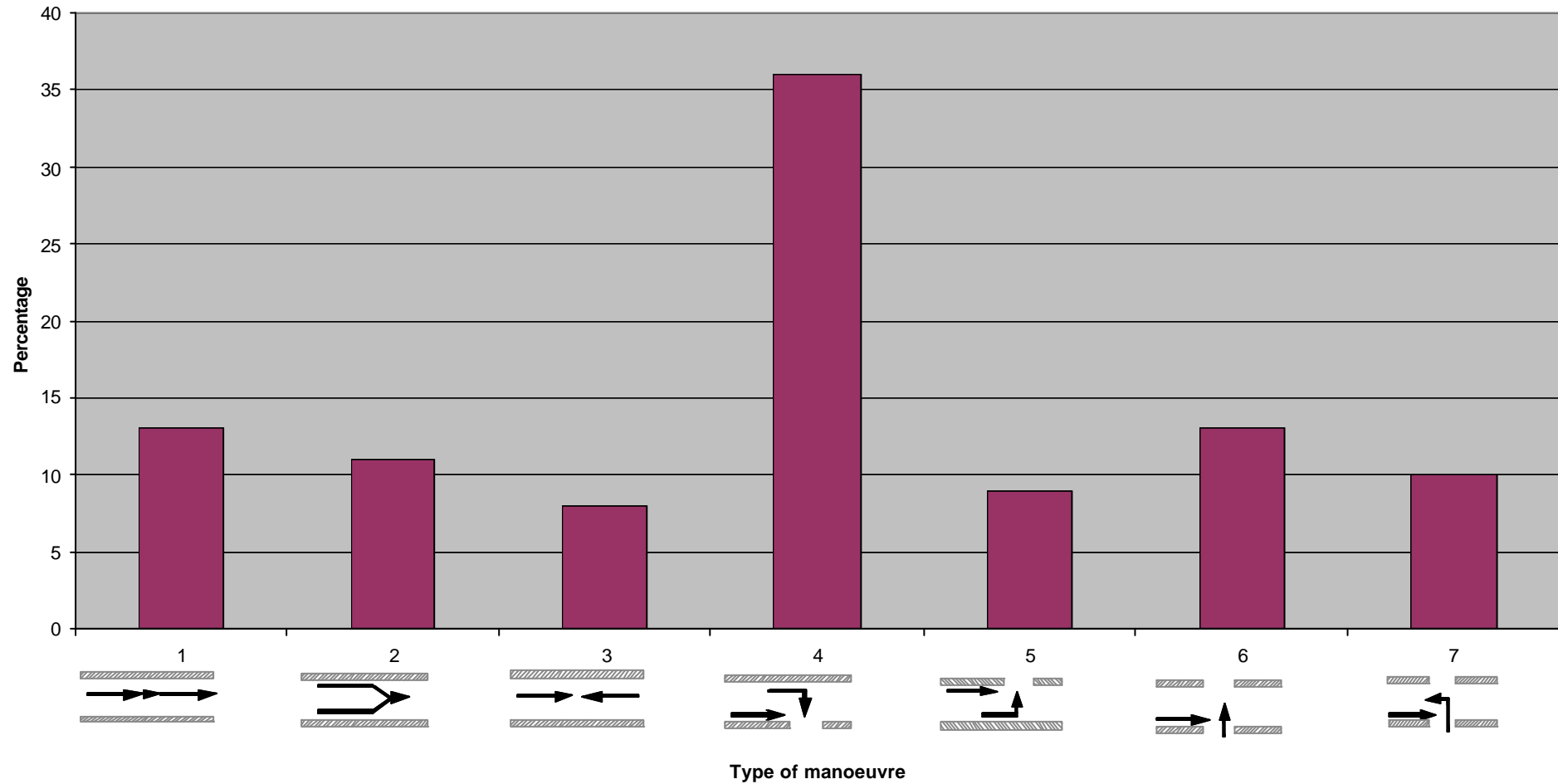
Figure 3-2 Cost of Implementation against benefit of casualty saving



Source: ICE Ergonomics, 1999 (Ref 81)

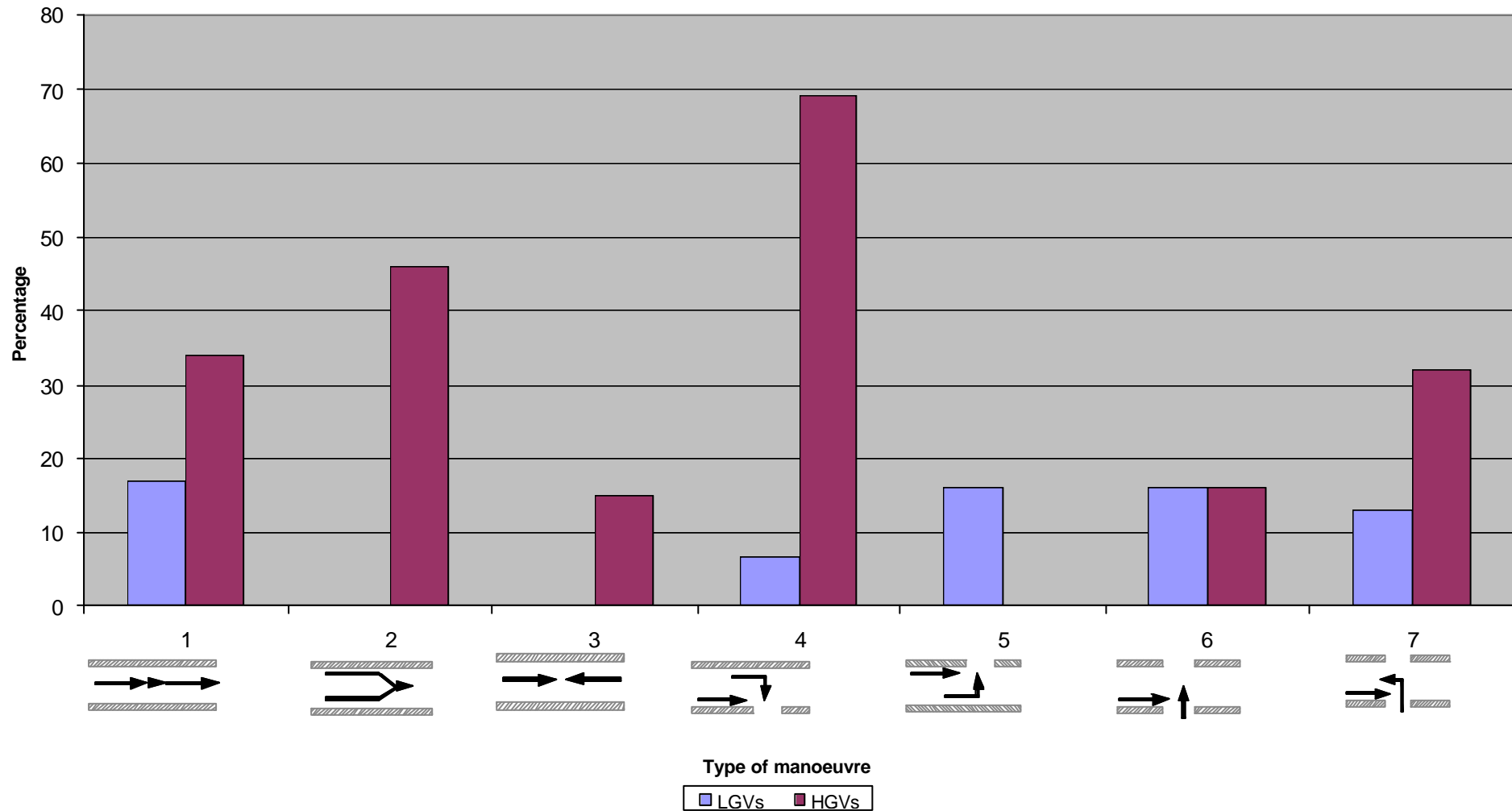


Figure 3-3 “Blind Spot” accidents as a proportion of total accidents in collisions between cycles/mopeds and goods vehicles, by type of manoeuvre



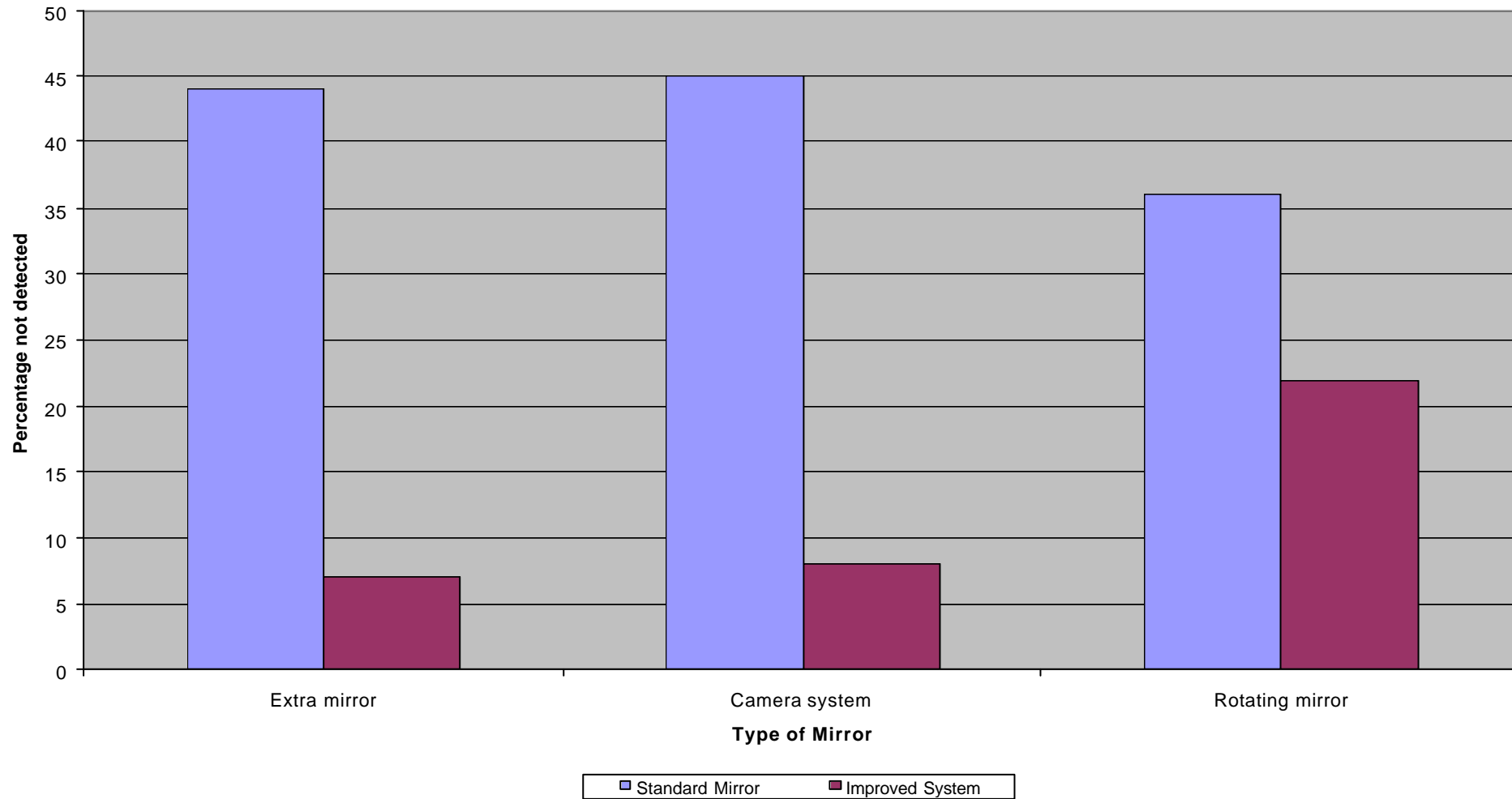
Source: TNO, 1998 (Ref 59)

Figure 3-4 Presence of goods vehicles in accidents with cyclists/mopeds



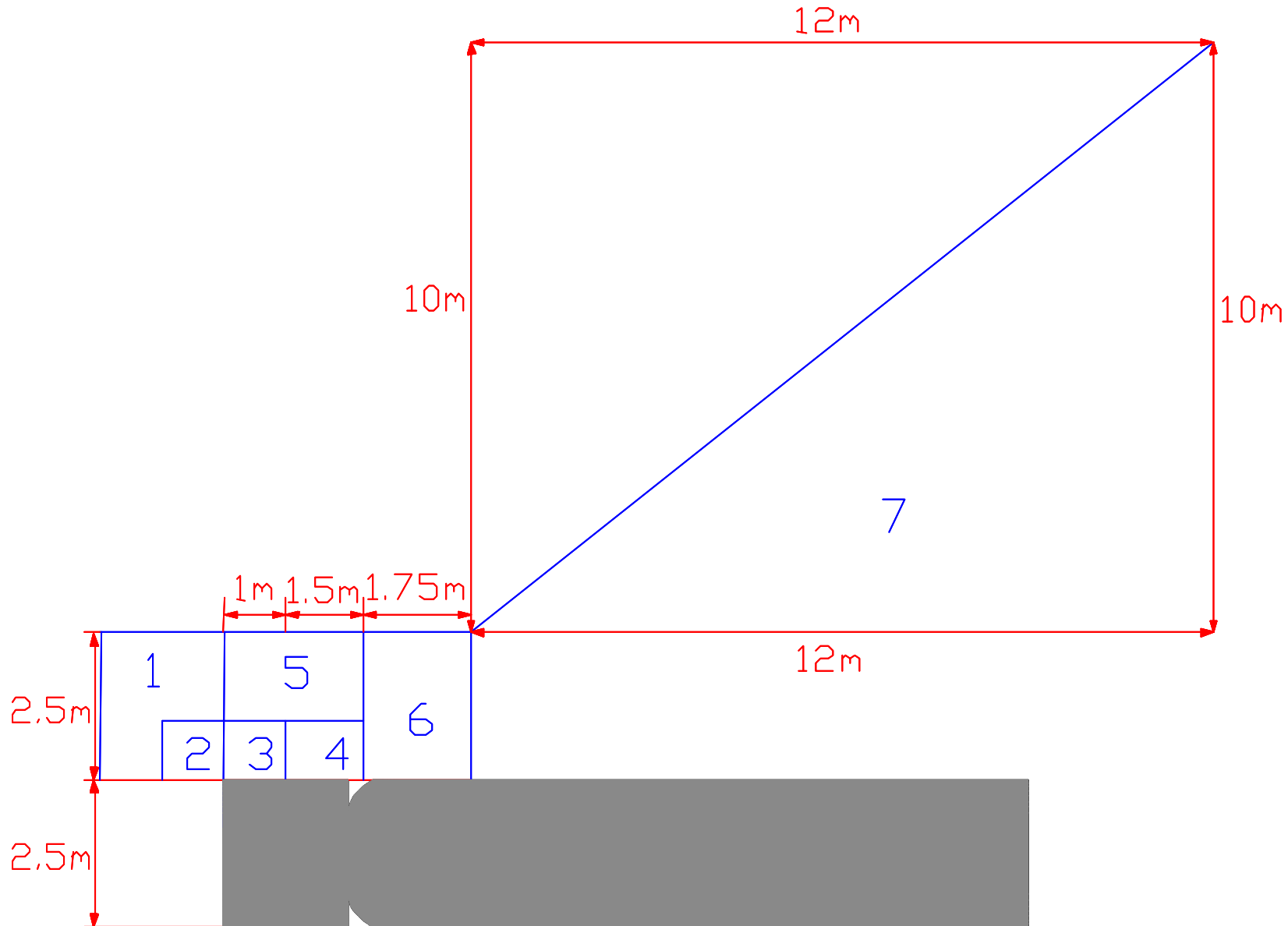
Source: TNO, 1998 (Ref 59)

Figure 3-5 Detection of potential collision victims



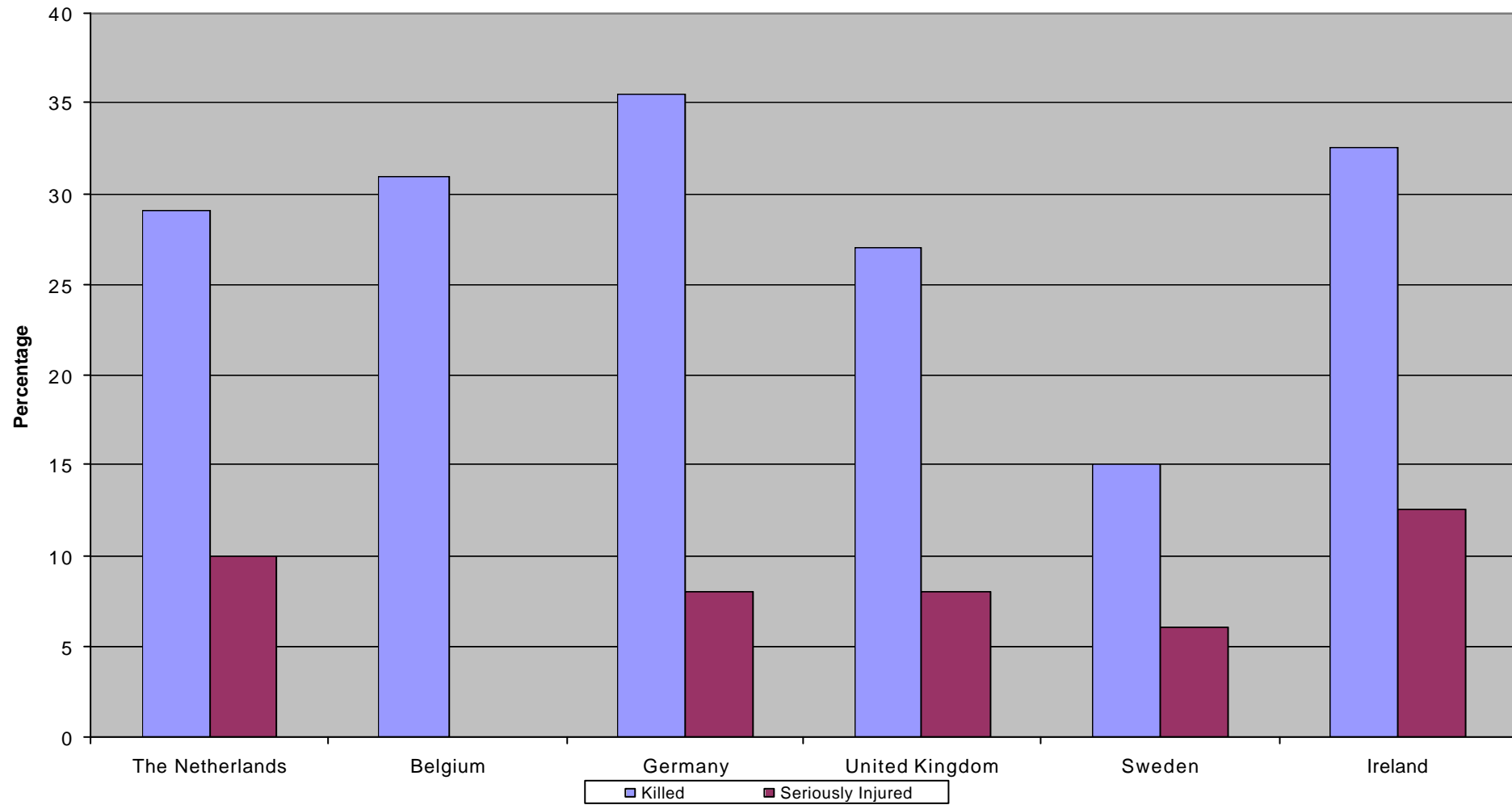
Source: TNO, 1999 (Ref 60)

Figure 3-6 Grid used for analysis of victim locations



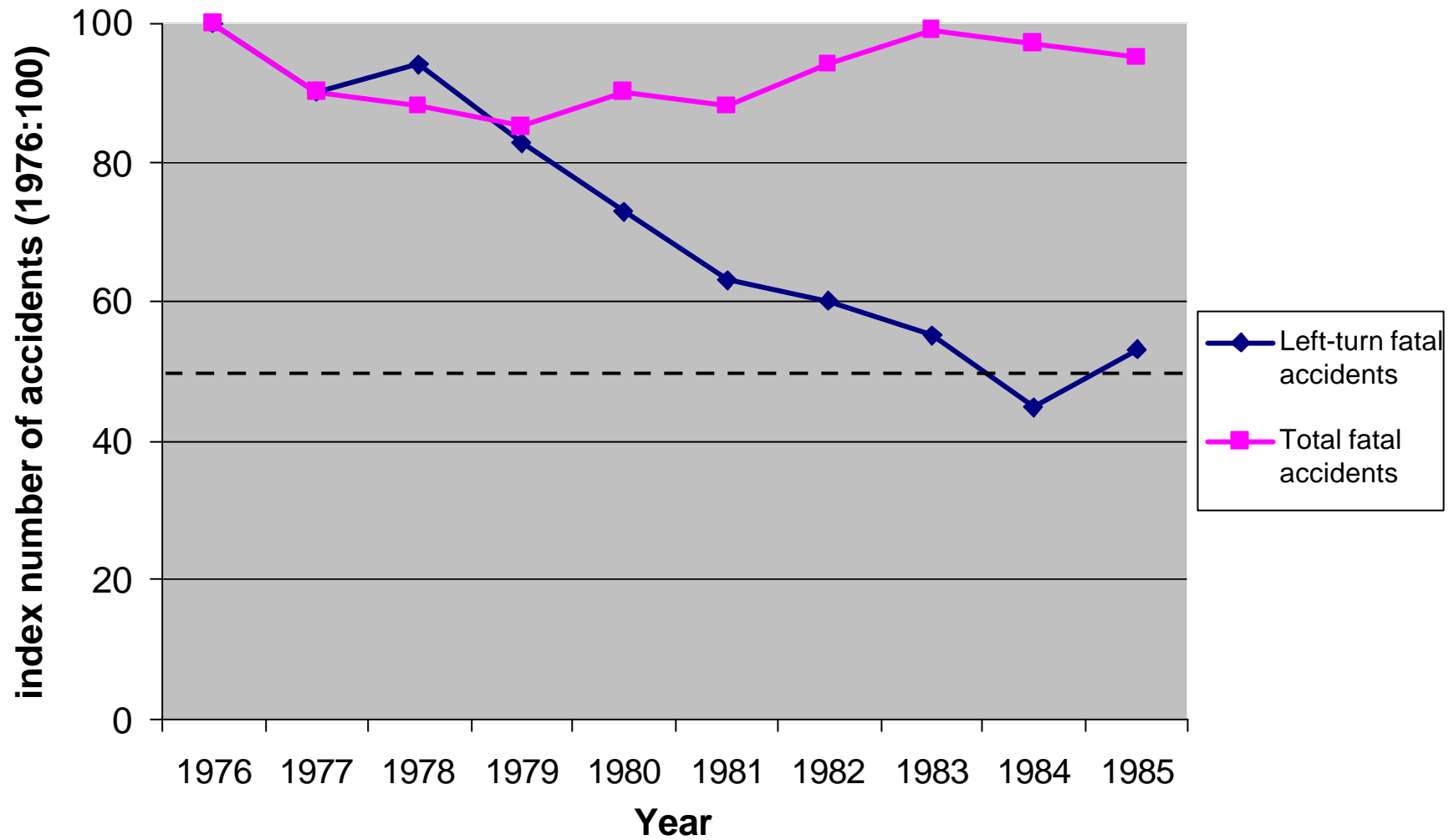
Source: TNO, January 2001 (Ref 61)

Figure 3-7 Goods vehicles involved in small two wheeled accidents



Source: TNO, November 2001 (Ref 9)

Figure 3-8 Regulatory improvements to driver vision in comparison to total accident fatalities in Japan



Source: dobli.com, (Ref 25)

## 4 STATISTICAL DATA COLLECTION (BASE DATA)

### 4.1 Vehicles

#### 4.1.1 Fleet composition

##### (a) Goods vehicles

The estimated 2001 fleet, broken down by GVW and by country, is shown in Table 4-2 and Table 4-3. The source data is not complete and is disaggregated by different GVW categories; adjustments had therefore to be made as shown in the table notes. The UK data came direct from vehicle licensing statistics. As might be expected, the largest fleets are in the biggest countries. The proportions by weight category are broadly similar across EU25; there is some correlation between the proportion of vehicles above 12 tonnes in the vehicle fleet and the size of each country (particularly in economic terms) but this does not apply to all countries.

As regards proportions of rigid and articulated vehicles, Table 4-4 comes from UK data and shows that articulated vehicles are a significant percentage of vehicles above 12 tonnes but not below. The percentage of articulated vehicles may vary across the EU but they will almost certainly be concentrated amongst the biggest vehicles.

##### (b) Buses and coaches

The estimated 2001 fleet, by country, is shown in Table 4-5. As with goods vehicles, the largest fleets are in the biggest countries. These are all vehicles with more than 8 seats. In the UK in 2001, the proportions by seat capacity were:

8 – 32 seats:	41%
32 – 48 seats:	18%
more than 48 seats:	41%.

#### 4.1.2 New registrations

This is important data because relating new registrations to the vehicle fleet gives a first indication of how long it will take to replace the existing fleet with new vehicles. Table 4-6 shows new goods vehicle registrations in EU15, first as a total number, then as a percentage of the fleet, and finally in terms of the number of years required to replace the fleet. The figures are shown for 2001 and 2002 because there are significant differences between registrations in the two years, 2001 generally being the higher.

There are some shortcomings in the data. Figures for Greece, and probably for Portugal, Finland, Luxembourg and Ireland, are wrong. There is no data for the new member countries. Nevertheless, in most countries 8-9% of the goods vehicle fleet is being replaced each year, requiring 11-12 years for the whole fleet to be replaced. The percentage of LGVs replaced is consistently more than HGVs.

These statistics are not the same as average vehicle age but are closely related.

#### 4.1.3 Average vehicle age

Figure 4-1 compares the average age of the vehicle fleets in the EU15 countries with six new member countries in 2000. Data is available from a number of sources,

including the EEA Fact Sheets and the IRU country sheets. Slovenia and Hungary have younger fleets than some EU15 members but in general the average age of vehicles in the new member countries (8 – 15 years) is higher than in EU15 (range of 4 – 10 years, with an average of 7.1 years).

Data presented in Figure 4-2 suggests that the average age of heavy vehicles (passenger and goods vehicles) in the new member countries is similar to passenger cars. In Slovenia and Poland, heavy vehicles are slightly older than passenger cars; in Hungary and Poland they are slightly younger.

In most countries the average age of the vehicle fleet is increasing, as shown by Figure 4-3. This also applies to EU15 as a whole, where the average age has risen from 6 years in 1980 to 7.1 years in 2000.

#### **4.1.4 Age profile**

Table 4-7 shows the age profile of relevant vehicle types in the 2002 UK fleet. The average age for all vehicles calculated from this profile (6.4 years) agrees with Figure 4-1. What this figure does not reveal is that more than 40% of the fleet is over 7 years, 23% over 10 years and 5% are more than 7 years. In general, the lower the average age, the fewer vehicles there are in the older age groups (the age profile has less of a “tail”) and this may be expected to apply throughout EU25. However, based on UK evidence there are many much older vehicles in the bus and coach fleet.

#### **4.1.5 Scrappage (no longer registered)**

“The average remaining years of life of a UK car may be estimated in a number of ways. One of the more accurate methods is seen in Figure 4-4, which plots the proportion of cars first registered in any year, which are scrapped (or no longer registered) year by year after their first registration. This shows that most British cars come to an end between 13 and 17 years after first registration. The average lifespan is 14 years. This should not be confused with the average age of the car fleet currently on British roads (with part of their life still to come), which is 7 years.

#### **4.1.6 Growth in new vehicle registrations**

In Table 2-1 and Table 4-9, new vehicle registrations from 1990 to 2002 are shown, together with average annual growth rates. These are compared with average annual GDP growth between 1990 and 2002. There is substantial variation in growth rates between countries but, if the more extreme values are excluded (eg for Greece, Poland and Portugal), most of the HGV growth rates for 1990-2001 are in the range of 1-2% per year. For LGV, there is a wider range between countries but the overall average is similar to that for HGV.

For buses and coaches, with the more extreme figures removed, most average annual growth rates from 1990 to 2001 are in the range of 2-5%; ie significantly higher than for goods vehicles.

Table 4-8 and Table 4-9 show that the EU15 average growth rates for HGV and LGV registrations for 1990-2001 were very close to the average growth in GDP. The correlation for individual countries is less strong. The average growth rate for bus and coach registrations is in the order of 1% above GDP growth.



#### 4.1.7 Future economic (GDP) growth

European Energy and Transport - Trends to 2030 (**Ref 123**) provides economic (GDP) forecasts for GDP to 2030. Forecast annual GDP growth rates are given in Table 4-10. These were used as the basis for forecasting future new vehicle registrations.

## 4.2 Accidents

### 4.2.1 Fatalities and PIA

#### (a) Number

The number of PIA, injured casualties and fatalities in EU25 in 1997 is shown in Table 4-11. Various ratios are also shown, including injuries per fatality. ICF (**Ref 30**) refer to a number of studies, which have noted undercounting of injuries of between 20% and 80%.

The analysis is concentrated on fatalities and PIA, as defined in Appendix D. Table 4-12 and Table 4-13 give numbers of fatalities in road accidents in EU15 and EU 25 from 1993 to 2003. The injury figures in Table 4-13 have been increased by factors of 1.3 to 1.8 (depending on the ratio of injuries per fatality) from the source data, to reflect the undercounting noted by ICF (**Ref 30**).

The number of accidents in EU15 is dominated by the five large member states; France, Germany, Italy, Spain and the United Kingdom with about 77% of fatalities and over 80% of PIA. Poland accounts for nearly 53% of fatalities in the new member countries.

There has been a steady decline in the number of fatalities in EU25 so that whereas there were more than 48,500 fatalities in EU15 in 1993, by 2002 this had decreased to less than 40,000. This trend has not been so evident in the new member countries where there were still more than 11,000 fatalities in 2002 and only 12% less than 1993 values. The reliability of the data is such that while the general conclusions are probably valid, the detailed figures are not always reliable.

### 4.2.2 Trends in accidents rates

It is clear from Table 4-14 that, whether measured against the size of the vehicle fleet or the kilometres driven, general accident rates have been falling steadily. Figure 4-5 uses four measures to compare accident risk:

- fatalities per million motor vehicles;
- fatalities per billion vehicle km;
- accidents per 1,000 motor vehicles;
- accidents per billion vehicle km.

Each is shown on a common scale, with 100 allocated to the highest figure, zero to the lowest and the intermediate figures scaled appropriately. The data is shown by country and colour-coded according to whether the country is large, medium or small. Some notable conclusions from the data are:

- Accident risk tends to be highest in the poorer countries of southern Europe and lowest in Scandinavia, although there are notable exceptions.
- The larger and more advanced countries tend to have the lowest fatality rates and higher accident rates, reflecting lesser severity and better accident treatment.

- On the basis of the one ratio available for the new member countries, accident risk is generally at the upper end of that exhibited by member states, but may be influenced by reporting rates.

#### **4.2.3 Breakdown by travel means of victim**

The data presented in Table 4-15 for 2001 shows that typically 35 – 45% of fatalities in EU15 are on two wheeled vehicles or are pedestrians. The proportions are remarkably consistent by country, with only Luxembourg falling significantly outside this range. Data for 1999 in Table 4-16 presents a similar picture for EU15. Figures are also available for 1999 for the new member countries. Fatalities on two wheelers and pedestrians typically account for 40 – 50% of accidents. The proportions of pedestrian and cycle fatalities in the new member countries are typically higher than in EU15, those for mopeds and motorcycles are typically lower.

Table 4-17 gives information for casualties in 1999, rather than fatalities; the pattern is broadly similar, except that cycle casualties are a significantly smaller proportion of the total than are fatalities in the new member countries, showing the increased severity of cycle accidents.

Table 4-18 supports this conclusion on the relative severity of pedestrian accidents. Cycle and motorcycle accident severity is also above the average for all vehicles. CETE in France have carried out an analysis that includes severity of pedestrian and cycle accidents from 1992 to 1997. The results are shown in Table 4.19 and generally support the above conclusions.

Figure 4-6 gives pedestrian and two-wheeled vehicle activity by country, separately for motorcycles, pedal cycles and pedestrians, in person km per head. The fatality figures correlate well with the person km data, particularly in regard to:

- the significance of Greece, Portugal and Italy for motorcycles;
- high levels of pedal cycle activity and accidents in the Netherlands and Denmark;
- the steady contribution of pedestrian incidents.

Pedestrian and two-wheeled vehicle accidents may be regarded as “urban” accidents, which in turn may be expected to correlate with measures of population and road concentration. Figure 4-7 shows four measures of population and road concentration:

- road density (km per square km);
- urban population (% of total);
- population density (population per square km).

Each is shown on a common scale, with 100 allocated to the highest figure, zero to the lowest and the intermediate figures scaled appropriately. The data is shown by country and colour-coded according to whether the country is large, medium or small. There is a strong correlation with cycling and cycling accidents, less with pedestrians and only weakly with motorcycling. Figure 4-7 includes the new member countries, which broadly have levels of population and road concentration at the lower end of the range in EU15, similar to Greece, Ireland, Portugal and Spain.

The DGTREN task manager provided the following data from the DGTREN road accident database for EU15 (except Germany):

- fatal accidents between heavy vehicles (HGV, LGV and bus/coach separately) and two wheelers/pedestrians (separately for motorcycles, cycles and pedestrians) for the last five years for which data is available;
- fatal accidents (as above) but for accidents in urban areas only.

The results are shown in Table 4-20 to Table 4-25, as an annual average. Estimates were made for those countries for which data was unavailable, as shown. It was assumed that there that there would be one fatality per fatal accident and therefore the data may be interpreted as “fatalities” as well as fatal accidents. Most importantly, the data allows disaggregation between frontal (front impact) and lateral (side impact) accidents.

Table 4-26 contains highly relevant information from various member states on the proportion of two-wheeler accidents involving goods vehicles. The number of accidents between goods vehicles and two wheelers broadly supports that in Table 4-20.

#### **4.2.4 Right turning two-wheeler accidents**

Table 4-27 shows the incidence of different vehicle types in two-wheeler accidents where the larger vehicle is turning right.

#### **4.2.5 Other characteristics which may influence accident rates**

The following may also be important:

- driver and rider behaviour;
- impairment of those involved;
- road engineering and speed management;
- socio-economic status eg risk of death for child pedestrians is highly class related (higher amongst lower social classes);
- education programmes;
- traffic flow;
- environmental factors; lighting and atmospheric conditions.

### 4.3 Valuation of accidents by type

Various estimates have been made in different countries and across the EU as a whole, for the cost of accidents by different type (e.g. fatal, serious injury, slight injury, damage only), with widely varying results. Focusing on fatalities only, a survey of the various studies of the value of a statistical life (**Ref 135**), shows a range of estimates from \$0.5m to \$31m, based on the US, various European countries and New Zealand.

In 1997, the European Commission introduced a “1 million ECU test rule” for road safety measures. This was based on the cost of all road accidents, divided by the number of fatalities across the EU in 1995 (**Ref 136**). The intention was to create an upper bound on the costs of road safety measures (in terms of cost per life saved), rather than to estimate the actual value of a life (which clearly the calculation does not do, since all accidents, including non-fatal and damage-only are included). This 1 million Euro rule was later modified by the a study by an ETSC working party, to take account of “value of human life factors”, as well as the economic costs included in the original calculation, and in addition, to take account of unreported injuries and accidents. This resulted in a value of €3.6m, calculated as total EU road accident costs of €162bn divided by total EU road accident fatalities in 1995 (45,000), of €3.6m (in 1995 prices).

In order to bring greater clarity to the analysis, it is useful to consider different categories of accident separately, to establish a cost per fatality (or per fatal accident), per non-fatal injury (or per non-fatal injury accident) and per damage-only accident. Since the ETSC calculation took costs of *all* accidents divided by fatalities, it would be reasonable to expect that the cost of *fatal* accidents per fatality would be lower than the ETSC value, which is indeed the case.

The approach taken here is to look at the values used by a number of different European countries, based on calculations of costs by accident categories, and the base data of the number of accidents, fatalities, injuries etc. Statistics from Germany (**Ref 138**), the UK (**Ref 139**) and the Netherlands (**Ref 140**) are presented Table 4-1, based on the latest available data, converted into € in 2004 prices (using the fixed NLG – Euro rate, and a conversion rate of GBP1 = €1.5).

**Table 4-1 Valuation of accidents by type and country\***

Unit costs € at 2004 prices			
	UK	Germany	Netherlands
Source year	2002	2001	1997
Fatality (cost per fatality)	1,989,012	1,309,998	1,669,479
Injury (cost per non-fatal injury)	40,228	41,434	38,908
Damage only (cost per accident)	2,371	6,777	1,742
Damage as a proportion of casualties accidents (cost)			
	UK	Germany	Netherlands
	39%	57%	35%

\* average for all types of accident

Source: (**Ref 138**, **Ref 139** and **Ref 140**)

More detailed analysis, and the source data for this table, is shown in Appendix G.

As a comparison, the equivalent cost per fatality in the US was calculated by the DoT's National Highway Transportation Safety Agency in 2000 as \$3.4 million (**Ref 137**). Translated into 2004 Euro prices, this corresponds approximately to €3 million. Given

the higher GDP per capita of the US compared to the European countries, and longer working lives, this does not look inconsistent with the European results.

Another reference suggests that a severe injury value is about 13% of a fatality and a slight injury is 1%. This was also based on a survey of a number of prior studies using a mixture of revealed and stated preference questionnaires to value saving one life in a large population of road users. The results produced a wide range of values partly explained by country examined and the year of data analysed.

Estimated accident costs for the UK, based on a study in 1995, are presented in the report by ICF (Ref 30). These are broadly consistent with the data from the DfT HEN1 used to source the table above, and are reproduced as Table 4-28. Table 4-28 also gives estimates of individual fatality and injury costs for accidents involving goods vehicles and buses. Property damage, insurance administration, police and delay costs have all been increased to recognise the fact that such vehicles are bigger, heavier and more valuable than the light vehicles involved in most crashes.

As part of this study, ICF also undertook a literature review of the costs of road congestion resulting from crashes and the cost of environmental damage from spills of harmful products. All available information indicated that delay costs could be substantial, in the order of several thousand euros per crash. A reasonably conservative value of €15 000 was estimated for fatal crashes and €5 000 for injury crashes.

**Table 4-2 Estimated EU25 goods vehicle fleets, 2001**

Country	Abbrev.	Gross vehicle weight (GVW)				Total
		< 3.5T	3.5 - 7.5T	7.5 - 12T	> 12T	
Austria	A	265	4	4	58	331
Belgium	B	447	31	17	30	526
Denmark	DK	334	10	4	45	393
Finland	FIN	247	6	9	47	309
France	F	4944	390	148	334	5816
Germany	D	2089	252	125	145	2611
Greece	EL	890	25	42	90	1047
Ireland	IRL	165	16	4	34	220
Italy	I	2688	306	141	224	3360
Luxembourg	L	18	1	0	2	21
Netherlands	NL	837	23	41	83	985
Portugal	P	1475	148	57	55	1735
Spain	E	3159	353	134	302	3949
Sweden	S	317	13	14	52	396
United Kingdom	UK	2538	152	13	257	2960
Cyprus	CY	106	4	2	6	118
Czech Republic	CZ	289	11	5	16	321
Estonia	EE	73	3	1	4	81
Hungary	HU	342	13	6	19	380
Latvia	LV	90	3	2	5	100
Lithuania	LT	90	3	2	5	100
Malta	MT	45	2	1	3	50
Poland	PL	1781	67	30	101	1979
Slovakia	SK	145	5	2	8	161
Slovenia	SL	50	2	1	3	56

Source: based on Eurostat

**Table 4-3 Estimated EU25 goods vehicle fleets (%), 2001**

Country	Abbrev.	Gross vehicle weight (GVW)				Total
		< 3.5T	3.5 - 7.5T	7.5 - 12T	> 12T	
Austria	A	80.0%	1.3%	1.2%	17.5%	100.0%
Belgium	B	85.0%	6.0%	3.3%	5.7%	100.0%
Denmark	DK	85.0%	2.5%	1.1%	11.5%	100.0%
Finland	FIN	80.0%	1.9%	3.0%	15.1%	100.0%
France	F	85.0%	6.7%	2.6%	5.7%	100.0%
Germany	D	80.0%	9.7%	4.8%	5.5%	100.0%
Greece	EL	85.0%	2.4%	4.1%	8.6%	100.0%
Ireland	IRL	75.0%	7.5%	2.0%	15.5%	100.0%
Italy	I	80.0%	9.1%	4.2%	6.7%	100.0%
Luxembourg	L	85.0%	5.0%	1.4%	8.7%	100.0%
Netherlands	NL	85.0%	2.3%	4.2%	8.5%	100.0%
Portugal	P	85.0%	8.5%	3.3%	3.2%	100.0%
Spain	E	80.0%	8.9%	3.4%	7.7%	100.0%
Sweden	S	80.0%	3.3%	3.6%	13.1%	100.0%
United Kingdom	UK	85.7%	5.1%	0.4%	8.7%	100.0%
Cyprus	CY	90.0%	3.4%	1.5%	5.1%	100.0%
Czech Republic	CZ	90.0%	3.4%	1.5%	5.1%	100.0%
Estonia	EE	90.0%	3.4%	1.5%	5.1%	100.0%
Hungary	HU	90.0%	3.4%	1.5%	5.1%	100.0%
Latvia	LV	90.0%	3.4%	1.5%	5.1%	100.0%
Lithuania	LT	90.0%	3.4%	1.5%	5.1%	100.0%
Malta	MT	90.0%	3.4%	1.5%	5.1%	100.0%
Poland	PL	90.0%	3.4%	1.5%	5.1%	100.0%
Slovakia	SK	90.0%	3.4%	1.5%	5.1%	100.0%
Slovenia	SL	90.0%	3.4%	1.5%	5.1%	100.0%

Source: based on Eurostat

**Table 4-4 UK goods vehicle fleet, 2001**

Body type	GVW			Total
	3.5 - 7.5T	7.5 - 12.5T	12.5T>	
<b>Thousands</b>				
Rigid	157.0	13.3	84.7	255.0
Articulated	0.1	0.0	115.4	115.5
Total	157.1	13.3	200.1	370.5
<b>Percentage</b>				
Rigid	99.9%	100.0%	42.3%	68.8%
Articulated	0.1%	0.0%	57.7%	31.2%
Total	100.0%	100.0%	100.0%	100.0%

Source: UK Vehicle Licensing Statistics, 2002 (Ref 113)

**Table 4-5 Bus and coach fleets, 2001**

Country	Abbrev.	M2 and M3
Austria	A	9.9
Belgium	B	14.7
Denmark	DK	14.0
Finland	FIN	9.9
France	F	85.7
Germany	D	86.5
Greece	EL	30.0
Ireland	IRL	7.0
Italy	I	88.0
Luxembourg	L	1.1
Netherlands	NL	11.3
Portugal	P	19.8
Spain	E	56.1
Sweden	S	14.2
United Kingdom	UK	88.5
Cyprus	CY	3.0
Czech Republic	CZ	18.4
Estonia	EE	5.5
Hungary	HU	18.1
Latvia	LV	11.6
Lithuania	LT	15.6
Malta	MT	1.1
Poland	PL	82.2
Slovakia	SK	10.9
Slovenia	SL	2.2

Source: based on Eurostat (from EU Energy and Transport in Figures)

**Table 4-6 EU15 goods vehicle registrations**

2001 registrations compared with 2001 fleet

Country	Abbrev.	Registrations			Percentage of fleet replaced			Years to replace fleet		
		LGV	HGV	Total	LGV	HGV	Total	LGV	HGV	Total
Austria	A	24.3	8.0	32.3	9.2%	12.1%	9.8%	10.9	8.3	10.2
Belgium	B	59.7	12.4	72.1	13.4%	15.7%	13.7%	7.5	6.4	7.3
Denmark	DK	31.5	4.6	36.1	9.4%	7.8%	9.2%	10.6	12.8	10.9
Finland	FIN	14.8	3.2	18.0	6.0%	5.2%	5.8%	16.7	19.3	17.2
France	F	433.1	57.9	491.0	8.8%	6.6%	8.4%	11.4	15.1	11.8
Germany	D	195.6	96.0	291.6	9.4%	18.4%	11.2%	10.7	5.4	9.0
Greece	EL	20.1	2.0	22.1	2.3%	1.3%	2.1%	44.3	78.5	47.4
Ireland	IRL	37.9	4.9	42.8	23.0%	8.9%	19.5%	4.4	11.2	5.1
Italy	I	208.1	38.1	246.2	7.7%	5.7%	7.3%	12.9	17.6	13.6
Luxembourg	L	3.8	1.3	5.1	21.3%	41.3%	24.3%	4.7	2.4	4.1
Netherlands	NL	84.6	17.2	101.8	10.1%	11.6%	10.3%	9.9	8.6	9.7
Portugal	P	105.3	6.7	112.0	7.1%	2.6%	6.5%	14.0	38.8	15.5
Spain	E	283.1	35.4	318.5	9.0%	4.5%	8.1%	11.2	22.3	12.4
Sweden	S	28.6	5.5	34.1	9.0%	6.9%	8.6%	11.1	14.4	11.6
United Kingdom	UK	256.7	54.8	311.5	10.1%	13.0%	10.5%	9.9	7.7	9.5
Total	EU15	1787.2	348.0	2135.2	8.8%	8.2%	8.7%	11.4	12.2	11.5

2002 registrations compared with 2001 fleet

Country	Abbrev.	Registrations			Percentage of fleet replaced			Years to replace fleet		
		LGV	HGV	Total	LGV	HGV	Total	LGV	HGV	Total
Austria	A	22.3	6.9	29.2	8.4%	10.4%	8.8%	11.9	9.6	11.3
Belgium	B	47.7	10.1	57.8	10.7%	12.8%	11.0%	9.4	7.8	9.1
Denmark	DK	31.4	4.1	35.5	9.4%	7.0%	9.0%	10.6	14.4	11.1
Finland	FIN	14.6	3.2	17.8	5.9%	5.2%	5.8%	16.9	19.3	17.4
France	F	404.0	51.6	455.6	8.2%	5.9%	7.8%	12.2	16.9	12.8
Germany	D	182.7	82.2	264.9	8.7%	15.7%	10.1%	11.4	6.4	9.9
Greece	EL	18.2	1.8	20.0	2.0%	1.1%	1.9%	48.9	87.3	52.4
Ireland	IRL	33.6	4.0	37.6	20.4%	7.3%	17.1%	4.9	13.8	5.9
Italy	I	268.4	39.7	308.1	10.0%	5.9%	9.2%	10.0	16.9	10.9
Luxembourg	L	3.9	1.0	4.9	21.8%	31.7%	23.3%	4.6	3.2	4.3
Netherlands	NL	80.3	14.5	94.8	9.6%	9.8%	9.6%	10.4	10.2	10.4
Portugal	P	78.8	4.8	83.6	5.3%	1.8%	4.8%	18.7	54.2	20.8
Spain	E	267.6	33.6	301.2	8.5%	4.3%	7.6%	11.8	23.5	13.1
Sweden	S	28.3	5.1	33.4	8.9%	6.4%	8.4%	11.2	15.5	11.9
United Kingdom	UK	259.6	51.1	310.7	10.2%	12.1%	10.5%	9.8	8.3	9.5
Total		1741.4	313.7	2055.1	8.5%	7.4%	8.3%	11.7	13.5	12.0

Source: AEA (published in EU Energy and Transport in Figures)



**Table 4-7 2002 vehicle fleet by date of first registration**

		pre 1986	1986	1987	1988	1989	1990	1991	1992	1993	1994	1995	1996	1997	1998	1999	2000	2001	2002	Total
	age range	17-18	16-17	15-16	14-15	13-14	12-13	11-12	10-11	9-10	8-9	7-8	6-7	5-6	4-5	3-4	2-3	1-2	0-1	
	average age	17.5	16.5	15.5	14.5	13.5	12.5	11.5	10.5	9.5	8.5	7.5	6.5	5.5	4.5	3.5	2.5	1.5	0.5	
<b>Cars and LGV</b>																				
All	thousands	646.9	221.3	352.3	588.6	874.6	1010.7	994.6	1147.8	1412.6	1600.7	1690.1	1810	1979.5	2101.6	2094.1	2223.6	2472	2560.8	25781.8
	percent	2.5%	0.9%	1.4%	2.3%	3.4%	3.9%	3.9%	4.5%	5.5%	6.2%	6.6%	7.0%	7.7%	8.2%	8.1%	8.6%	9.6%	9.9%	100.0%
<b>HGV</b>																				
3.5 - 7.5T	thousands	3.9	2.0	3.3	5.1	6.2	5.3	4.1	5.0	5.5	7.8	9.5	9.9	10.7	13.7	13.2	15.0	16.0	14.6	150.8
	percent	2.6%	1.3%	2.2%	3.4%	4.1%	3.5%	2.7%	3.3%	3.6%	5.2%	6.3%	6.6%	7.1%	9.1%	8.8%	9.9%	10.6%	9.7%	100.0%
7.5 - 12T	thousands	0.4	0.2	0.3	0.4	0.5	0.5	0.3	0.5	0.6	0.6	0.8	0.9	0.8	0.9	1.0	1.1	1.1	1.1	12.0
	percent	3.3%	1.7%	2.5%	3.3%	4.2%	4.2%	2.5%	4.2%	5.0%	5.0%	6.7%	7.5%	6.7%	7.5%	8.3%	9.2%	9.2%	9.2%	100.0%
>12T	thousands	2.5	1.4	2.5	4.3	6.2	5.2	4.4	5.5	8.7	13.8	19.0	19.9	20.4	25.4	28.4	31.6	32.4	31.0	262.6
	percent	1.0%	0.5%	1.0%	1.6%	2.4%	2.0%	1.7%	2.1%	3.3%	5.3%	7.2%	7.6%	7.8%	9.7%	10.8%	12.0%	12.3%	11.8%	100.0%
All	thousands	6.8	3.6	6.1	9.8	12.9	11.0	8.8	11.0	14.8	22.2	29.3	30.7	31.9	40.0	42.6	47.7	49.5	46.7	425.4
	percent	1.6%	0.8%	1.4%	2.3%	3.0%	2.6%	2.1%	2.6%	3.5%	5.2%	6.9%	7.2%	7.5%	9.4%	10.0%	11.2%	11.6%	11.0%	100.0%
<b>Buses and coaches</b>																				
> 8 seats	thousands	12.0	1.7	1.6	2.7	3.4	3.2	2.4	2.6	3.3	4.1	5.4	6.2	6.4	7.3	7.6	7.2	7.0	8.4	92.5
	percent	13.0%	1.8%	1.7%	2.9%	3.7%	3.5%	2.6%	2.8%	3.6%	4.4%	5.8%	6.7%	6.9%	7.9%	8.2%	7.8%	7.6%	9.1%	100.0%
<b>Total</b>																				
	thousands	672.5	230.2	366.1	610.9	903.8	1035.9	1014.6	1172.4	1445.5	1649.2	1754.1	1877.6	2049.7	2188.9	2186.9	2326.2	2578.0	2662.6	26725.1
	percent	2.5%	0.9%	1.4%	2.3%	3.4%	3.9%	3.8%	4.4%	5.4%	6.2%	6.6%	7.0%	7.7%	8.2%	8.2%	8.7%	9.6%	10.0%	100.0%

>17   >16   >15   >14   >13   >12   >11   >10   >9   >8   >7   >6   >5   >4   >3   >2   >1   >0  
 2.5%   3.4%   4.7%   7.0%   10.4%   14.3%   18.1%   22.5%   27.9%   34.1%   40.6%   47.6%   55.3%   63.5%   71.7%   80.4%   90.0%   100.0%

Source: Vehicle Licensing Statistics, 2002 (Ref 113)

**Table 4-8 New bus and coach registration growth**

HGV (>3.5T)

Country	Abbrev.	Registrations (thousands)					Growth	
		1990	1998	1999	2001	2002	1990-2001	1990-2002
Austria	A	7.2	7.9	8.4	8.0	6.9	11%	-4%
Belgium	B	10.7	10.0	11.4	12.4	10.1	16%	-6%
Denmark	DK	3.5	5.3	5.2	4.6	4.1	31%	17%
Finland	FIN	4.2	3.3	3.2	3.2	3.2	-24%	-24%
France	F	50.0	47.4	53.6	57.9	51.6	16%	3%
Germany	D	73.8	87.8	99.9	96.0	82.2	30%	11%
Greece	EL	0.5	1.0	1.7	2.0	1.8	300%	260%
Ireland	IRL	2.7	3.9	4.6	4.9	4.0	81%	48%
Italy	I	32.0	22.5	33.5	38.1	39.7	19%	24%
Luxembourg	L	1.1	0.9	1.1	1.3	1.0	18%	-9%
Netherlands	NL	14.8	17.6	16.4	17.2	14.5	16%	-2%
Portugal	P	7.2	5.6	7.0	6.7	4.8	-7%	-33%
Spain	E	30.4	26.2	31.9	35.4	33.6	16%	11%
Sweden	S	6.0	4.4	5.8	5.5	5.1	-8%	-15%
United Kingdom	UK	45.8	50.4	49.5	54.8	51.1	20%	12%
EU total	EU15	289.9	294.2	333.2	348.0	313.7	20%	8%

LGV (<3.5T)

Country	Abbrev.	Registrations (thousands)					Growth	
		1990	1998	1999	2001	2002	1990-2001	1990-2002
Austria	A	21.5	24.9	25.2	24.3	22.3	13%	4%
Belgium	B	52.5	50.3	58.2	59.7	47.7	14%	-9%
Denmark	DK	19.6	29.1	32.1	31.5	31.4	61%	60%
Finland	FIN	27.5	15.8	16.3	14.8	14.6	-46%	-47%
France	F	393.8	347.1	375.1	433.1	404.0	10%	3%
Germany	D	125.4	203.7	218.1	195.6	182.7	56%	46%
Greece	EL	29.5	16.8	21.6	20.1	18.2	-32%	-38%
Ireland	IRL	24.1	27.3	33.8	37.9	33.6	57%	39%
Italy	I	157.0	168.1	178.5	208.1	268.4	33%	71%
Luxembourg	L	1.9	2.6	3.1	3.8	3.9	100%	105%
Netherlands	NL	53.1	96.7	99.5	84.6	80.3	59%	51%
Portugal	P	64.2	119.9	130.3	105.3	78.8	64%	23%
Spain	E	229.8	255.0	309.0	283.1	267.6	23%	16%
Sweden	S	26.4	26.4	28.4	28.6	28.3	8%	7%
United Kingdom	UK	247.7	243.4	237.8	256.7	259.6	4%	5%
EU total	EU15	1474.0	1627.1	1767.0	1787.2	1741.4	21%	18%

Source: CCFA and ACEA (published by EU Energy and Transport)

**Table 4-9 New bus and coach registration growth**

Country	Abbrev.	Registrations (thousands)					Growth	
		1990	1998	1999	2001	2002	1990-2001	1990-2002
Austria	A	0.45	0.49	0.70	0.60	0.70	33%	56%
Belgium	B	0.58	0.86	0.78	0.89	1.02	53%	76%
Denmark	DK	0.31	0.61	0.46	0.38	0.57	23%	84%
Finland	FIN	0.43	0.34	0.38	0.18	0.35	-58%	-19%
France	F	3.16	4.09	4.44	5.26	5.30	66%	68%
Germany	D	4.24	5.22	5.69	5.98	5.59	41%	32%
Greece	EL	0.63	0.17	0.52	0.71	0.19	13%	-70%
Ireland	IRL	0.02	0.11	0.15	0.08	0.08	300%	300%
Italy	I	3.83	3.43	4.06	5.52	4.81	44%	26%
Luxembourg	L	0.06	0.10	0.12	0.15	0.09	150%	50%
Netherlands	NI	1.07	0.51	0.64	0.85	0.71	-21%	-34%
Portugal	P	0.48	0.58	0.48	0.87	0.69	81%	44%
Spain	E	2.38	2.97	3.09	3.43	3.08	44%	29%
Sweden	S	0.86	0.81	1.02	1.11	1.17	29%	36%
United Kingdom	UK	3.32	4.57	4.75	4.60	4.83	39%	45%
EU total	EU15	21.82	24.86	27.28	30.61	29.18	40%	34%

Source: CCFA and ACEA (published by EU Energy and Transport)

**Table 4-10 Annual GDP growth forecasts**

Country	2002-2003	2003-2005	2005-2010	2010-2015	2015-2020
Austria	2.5%	2.7%	2.2%	2.1%	2.0%
Belgium	2.8%	3.0%	2.2%	1.9%	1.7%
Denmark	2.5%	2.2%	2.4%	1.9%	1.8%
Finland	3.3%	3.4%	2.6%	1.7%	1.6%
France	2.8%	3.0%	2.3%	2.3%	2.2%
Germany	2.7%	2.9%	2.2%	2.1%	2.1%
Greece	4.2%	5.1%	3.5%	3.3%	3.2%
Ireland	6.1%	6.3%	3.6%	2.5%	2.2%
Italy	2.7%	2.9%	2.4%	2.3%	2.2%
Luxembourg	5.2%	5.9%	4.2%	3.2%	2.7%
Netherlands	2.7%	2.8%	2.4%	2.3%	2.3%
Portugal	2.2%	3.0%	3.8%	3.7%	3.6%
Spain	3.2%	3.4%	3.0%	2.9%	2.8%
Sweden	2.8%	2.5%	2.4%	2.2%	2.1%
United Kingdom	3.0%	2.7%	2.6%	2.5%	2.5%
Cyprus	4.0%	4.2%	3.6%	3.4%	3.1%
Czech Rep.	3.9%	3.9%	3.5%	3.1%	2.6%
Estonia	5.3%	5.2%	3.6%	3.0%	2.3%
Hungary	4.5%	4.4%	3.6%	3.2%	2.4%
Latvia	6.0%	5.7%	4.2%	3.5%	2.9%
Lithuania	5.0%	4.7%	4.6%	4.0%	3.6%
Malta	4.0%	3.8%	3.7%	4.1%	4.2%
Poland	3.2%	4.5%	4.7%	4.5%	4.1%
Slovakia	4.2%	4.1%	4.0%	3.8%	3.6%
Slovenia	4.0%	4.0%	3.3%	2.5%	2.1%

Source: European and Transport Trends to 2030 (123)

**Table 4-11 Accidents and casualty data for 2001**

Country	Abbrev.	PIA	Injuries	Fatalities	Injuries per PIA	Injuries per fatality	Fatalities per thousand PIA
Austria	A	43,073	49,696	958	1.15	52	22
Belgium	B	47,444	65,294	1,486	1.38	44	31
Denmark	DK	6,856	8,465	431	1.23	20	63
Finland	FIN	6,451	8,411	433	1.30	19	67
France	F	116,745	153,945	8,162	1.32	19	70
Germany	D	375,345	494,775	6,977	1.32	71	19
Greece	EL	19,671	26,336	1,880	1.34	14	96
Ireland	IRL	6,909	10,405	412	1.51	25	60
Italy	I	235,142	334,679	6,682	1.42	50	28
Luxembourg	L	774	1,176	70	1.52	17	90
Netherlands	NL	35,313	42,810	993	1.21	43	28
Portugal	P	42,521	57,044	1,670	1.34	34	39
Spain	E	100,393	150,305	5,517	1.50	27	55
Sweden	S	15,796	22,330	583	1.41	38	37
United Kingdom	UK	236,461	317,306	3,598	1.34	88	15
<b>Total</b>	<b>EU15</b>	<b>1,288,894</b>	<b>1,742,977</b>	<b>39,852</b>	<b>1.35</b>	<b>44</b>	<b>31</b>
Cyprus	CY	2,393	3,528	98	1.47	36	41
Czech Rep.	CZ	26,027	33,676	1,334	1.29	25	51
Estonia	EE	1,888	2,443	199	1.29	12	105
Hungary	HU	18,505	24,149	1,239	1.30	19	67
Latvia	LV	4,766	5,852	517	1.23	11	108
Lithuania	LT	5,972	7,103	706	1.19	10	118
Malta	MT	1,231	1,215	16	0.99	76	13
Poland	PL	53,799	68,194	5,534	1.27	12	103
Slovakia	SK	8,181	10,839	614	1.32	18	75
Slovenia	SL	9,198	12,673	278	1.38	46	30
<b>Total</b>	<b>New</b>	<b>131,960</b>	<b>169,672</b>	<b>10,535</b>	<b>1.29</b>	<b>16</b>	<b>80</b>

Source: based on information provided by DG TREN (30/07/2004) with adjustment for injury undercounting from ICF (Ref 30)

Table 4-12 Fatalities

Country	Abbrev.	1993	1994	1995	1996	1997	1998	1999	2000	2001	2002	2003 est.	Percent 2002
Austria	A	1,283	1,338	1,210	1,027	1,105	963	1,079	976	958	956	931	2.5%
Belgium	B	1,660	1,692	1,449	1,356	1,364	1,500	1,397	1,470	1,486	1,315	-	3.4%
Denmark	DK	559	546	582	514	489	499	514	498	431	463	432	1.2%
Finland	FIN	484	480	441	404	438	400	431	396	433	415	377	1.1%
France	F	9,867	9,019	8,891	8,541	8,444	8,918	8,487	8,079	8,160	7,655	6,020	19.8%
Germany	D	9,949	9,814	9,454	8,758	8,549	7,792	7,772	7,503	6,977	6,842	6,613	17.7%
Greece	EL	2,159	2,253	2,411	2,157	2,105	2,182	2,116	2,037	1,880	1,654	-	4.3%
Ireland	IRL	431	404	437	453	473	458	414	418	412	376	339	1.0%
Italy	I	7,188	7,091	7,020	6,676	6,713	6,314	6,633	6,410	6,682	6,736	-	17.4%
Luxembourg	L	78	65	70	71	60	57	58	70	69	62	53	0.2%
Netherlands	NL	1,235	1,298	1,334	1,180	1,163	1,066	1,090	1,082	993	987	1,028	2.6%
Portugal	P	2,700	2,504	2,711	2,730	2,521	2,126	2,028	1,874	1,671	1,655	1,532	4.3%
Spain	E	6,376	5,614	5,749	5,482	5,604	5,957	5,738	5,777	5,516	5,347	5,394	13.9%
Sweden	S	632	589	572	537	541	531	580	591	583	560	530	1.5%
United Kingdom	UK	3,957	3,807	3,765	3,740	3,743	3,581	3,564	3,580	3,598	3,581	3,658	9.3%
Total	EU15	48,558	46,514	46,096	43,626	43,312	42,344	41,901	40,761	39,849	38,604	n.a	100%
Cyprus	CY	115	133	118	128	115	111	113	111	98	98	98	0.9%
Czech Republic	CZ	1,524	1,637	1,588	1,562	1,597	1,360	1,455	1,486	1,334	1,431	1,447	12.9%
Estonia	EE	321	364	332	213	280	284	232	204	199	224	164	2.0%
Hungary	HU	1,678	1,562	1,589	1,370	1,391	1,371	1,306	1,200	1,239	1,429	1,326	12.9%
Latvia	LV	670	717	611	550	525	627	604	588	517	518	493	4.7%
Lithuania	LT	958	765	672	667	725	829	748	641	706	697	709	6.3%
Malta	MT	14	6	14	19	18	17	4	15	16	16	16	0.1%
Poland	PL	6,341	6,744	6,900	6,359	7,310	7,080	6,730	6,294	5,534	5,827	5,695	52.4%
Slovakia	SK	584	633	660	616	788	819	647	628	614	610	-	5.5%
Slovenia	SL	493	505	415	389	357	309	334	313	278	269	242	2.4%
Total	New	12,698	13,066	12,899	11,873	13,106	12,807	12,173	11,480	10,535	11,119	n.a	100%
Total	EU25	61,256	59,580	58,995	55,499	56,418	55,151	54,074	52,241	50,384	49,723	n.a	

Fatalities are all persons killed within 30 days from the day of the accident;  
For Member States not using this definition corrective factors were applied

Source: DGTREN website (road safety section)

Table 4-13 Injuries

Country	Abbrev.	1993	1994	1995	1996	1997	1998	1999	2000	2001	2002	2003	Percent 2001
Austria	A	70	70	67	65	68	68	73	73	75	75	75	2.8%
Belgium	B	106	103	98	94	97	99	100	95	91	80	-	3.4%
Denmark	DK	18	18	18	18	17	17	17	16	15	16	15	0.6%
Finland	FIN	14	15	18	17	16	16	16	15	15	15	15	0.6%
France	F	340	325	327	306	305	303	302	292	277	248	228	10.4%
Germany	D	708	723	717	690	702	696	730	706	693	667	649	26.1%
Greece	EL	54	55	56	59	60	61	59	55	47	40	-	1.8%
Ireland	IRL	17	17	22	23	23	22	21	21	18	16	16	0.7%
Italy	I	346	383	415	435	434	470	517	515	535	541	-	20.2%
Luxembourg	L	3	3	3	3	3	3	3	2	2	3	2	0.1%
Netherlands	NL	72	74	76	73	74	74	77	69	64	61	57	2.4%
Portugal	P	120	112	118	120	120	120	119	109	103	102	-	3.9%
Spain	E	213	206	220	225	227	256	259	271	271	266	271	10.2%
Sweden	S	32	34	34	33	34	34	35	35	36	39	40	1.3%
United Kingdom	UK	407	421	414	428	438	418	412	412	412	398	382	15.5%
Total	EU15	2518	2557	2604	2590	2617	2658	2738	2686	2654	0	n.a	100%
Cyprus	CY	0	0	8	0	8	7	7	6	6	6	6	2.1%
Czech Republic	CZ	58	64	67	68	66	63	62	58	61	-	-	19.8%
Estonia	EE	3	3	3	3	3	4	3	3	4	5	5	1.4%
Hungary	HU	46	49	47	43	45	48	44	41	43	-	43	14.2%
Latvia	LV	7	8	9	8	8	10	9	10	11	11	11	3.4%
Lithuania	LT	8	7	8	9	11	14	14	13	13	13	13	4.2%
Malta	MT	1	1	1	0	1	2	2	2	2	2	2	0.7%
Poland	PL	106	116	126	129	150	140	123	129	123	121	115	40.2%
Slovakia	SK	0	0	21	0	23	23	21	18	20	-	-	6.4%
Slovenia	SL	0	0	14	0	16	13	16	21	23	26	31	7.5%
Total	New	228	249	304	260	331	323	302	301	305	n.a	n.a	100%
Total	EU25	2747	2806	2908	2849	2948	2981	3040	2988	2960	n.a	n.a	EU25

Notes: factored for under-reporting

Source: Based on information provided by DG TREN (30/07/2004)

**Table 4-14 Fatality and accident rates**

Measure	Grouping	1990	1991	1995	2001
Fatalities per million motor vehicles	EU15	328		212	171
Fatalities per billion vehicle km	EU15		21.6		15.4
Accidents per 1,000 motor vehicles	EU15	8.2		6.1	5.6
Accidents per 1,000 motor vehicles	new members	8.3	7.0	5.4	
Accidents per billion vehicle km	EU15		540		446

Source: Based on UNECE website and IRTAD

**Table 4-15 Two wheeler and pedestrian fatalities as a % of total fatalities, 2001**

Country	Abbrev.	Fatalities (% of total fatalities)			
		M'cycle*	Pedal cycles	Pedestrians	Two wheelers plus pedestrians
Austria	A	15.0	5.7	12.2	33.0
Belgium	B	14.1	8.7	10.6	33.5
Denmark	DK	12.8	13.0	11.4	37.1
Finland	FIN	5.3	13.6	14.3	33.3
France	F	18.9	3.1	10.1	32.1
Germany	D	14.5	8.5	12.6	35.6
Greece	EL	26.8	1.5	18.0	46.3
Ireland	IRL	12.1	2.9	21.8	36.9
Italy	I	18.9	5.8	14.2	38.8
Luxembourg	L	5.0	1.7	13.3	20.0
Netherlands	NL	16.7	17.8	10.3	44.8
Portugal	P	23.9	3.0	20.2	47.0
Spain	E	15.1	1.8	15.3	32.2
Sweden	S	8.1	7.4	14.9	30.4
United Kingdom	UK	16.2	3.8	27.1	47.1
Total	EU15	17.7	4.6	15.0	37.3
Cyprus	CY				
Czech Republic	CZ	8.1	9.8	23.5	41.4
Estonia	EE	2.6	4.3	35.3	42.2
Hungary	HU	6.8	15.1	29.3	51.2
Latvia	LV	3.6	4.3	33.4	41.3
Lithuania	LT	3.4	7.8	36.0	47.2
Malta	MT	0.0			0.0
Poland	PL	3.2	11.2	36.9	51.3
Slovakia	SK	0.0			0.0
Slovenia	SL	12.9	8.7	18.3	39.9
Total	New	4.6	10.7	33.5	48.8

Note: EU15 generally for 2001; new member country data relates to 1999  
\* assumed to include moped

Source: EU15 based on DGTREN website (road safety section) and new members on ECMT Accident Statistics Database (Ref 53)

**Table 4-16 Two wheeler and pedestrian fatalities as a % of total fatalities, 1999**

Country	Abbrev.	Fatalities (% of total fatalities)				
		Pedestrian	Cycle	Moped	Motorcycle	Two wheelers plus pedestrians
Austria	A	16.9	6.3	4.4	9.5	37.1
Belgium	B	11.0	8.7	4.0	10.2	33.9
Denmark	DK	16.0	11.5	8.0	5.1	40.6
Finland	FIN	15.5	14.6	1.9	3.0	35.0
France	F	11.0	3.8	5.8	11.2	31.8
Germany	D	12.6	8.5	1.9	12.6	35.6
Greece	EL					
Ireland	IRL	22.3	3.4		10.4	36.1
Italy	I					
Luxembourg	L	3.4		1.7	8.6	13.7
Netherlands	NL	10.2	17.8	9.8	6.9	44.7
Portugal	P	19.7	2.1	12.7	12.7	47.2
Spain	E	15.8	2.1	9.0	6.8	33.7
Sweden	S	14.8	7.8	2.1	6.2	30.9
United Kingdom	UK	25.4	5.0	0.5	15.5	46.4
Total	EU15	14.8	5.7	5.1	10.8	36.4
Cyprus	CY					
Czech Republic	CZ	23.5	9.8	0.7	7.4	41.4
Estonia	EE	35.3	4.3	1.3	1.3	42.2
Hungary	HU	29.3	15.1	3.0	3.8	51.2
Latvia	LV	33.4	4.3	1.0	2.6	41.3
Lithuania	LT	36.0	7.8	1.3	2.1	47.2
Malta	MT					
Poland	PL	36.9	11.2		3.2	51.3
Slovakia	SK					
Slovenia	SL	18.3	8.7	5.4	7.5	39.9
Total	New	33.5	10.7	0.8	3.8	48.7

Source: Based on ECMT Accident Statistics Database (Ref 53)



**Table 4-17 Two wheeler and pedestrian casualties as a % of total casualties, 1999**

Country	Abbrev.	Casualties (% of total casualties)				
		Pedestrian	Cycle	Moped	Motorcycle	Two wheelers plus pedestrians
Austria	A	8.2	10.4	8.0	6.4	33.0
Belgium	B	5.7	10.0	11.7	5.1	32.5
Denmark	DK	9.4	18.8	11.0	4.1	43.3
Finland	FIN	9.9	13.3	4.7	4.2	32.1
France	F	11.1	3.7	11.7	11.4	37.9
Germany	D	7.6	14.3	3.7	8.3	33.9
Greece	EL					
Ireland	IRL	11.0	3.7		7.7	22.4
Italy	I					
Luxembourg	L	10.0	2.5	1.7	7.1	21.3
Netherlands	NL	7.2	9.1	18.6	6.5	41.4
Portugal	P	13.0	2.6	17.0	9.1	41.7
Spain	E	8.8	1.5	19.3	7.5	37.1
Sweden	S	6.6	11.6	3.4	3.8	25.4
United Kingdom	UK	13.4	7.1	1.0	7.2	28.7
Total	EU15	9.7	7.3	10.0	8.4	35.4
Cyprus	CY					
Czech Republic	CZ	15.1	12.5	0.9	7.3	35.8
Estonia	EE	29.9	7.8	0.9	4.2	42.8
Hungary	HU	16.4	13.0	4.9	4.0	38.3
Latvia	LV	29.8	4.6	1.2	3.2	38.8
Lithuania	LT	30.8	6.3	1.3	3.2	41.6
Malta	MT					
Poland	PL	29.7	10.1		2.7	42.5
Slovakia	SK					
Slovenia	SL	8.7	6.7	6.7	3.9	26.0
Total	New	25.8	10.1	1.0	3.6	40.4

Source: Based on ECMT Accident Statistics Database (Ref 53)

**Table 4-18 Severity of accidents by vehicle type**

Country	Abbrev.	Fatalities per 1,000 injuries					Injuries per fatality	
		Pedestrian	Cycle	Moped	Motorcycle	All vehs	Two wheelers	Pedestrians
Austria	A	39	12	11	29	19	62	26
Belgium	B	38	17	7	38	19	59	26
Denmark	DK	88	32	38	64	52	26	11
Finland	FIN	71	50	18	33	45	25	14
France	F	45	47	23	45	46	28	22
Germany	D	24	9	8	22	15	76	42
Greece	EL	68	36	26	50	42	27	15
Ireland	IRL	66	29	63	44	32	25	15
Italy	I	54	43	14	47	40	48	19
Luxembourg	L	13	59	37	44	37	22	77
Netherlands	NL	115	75	43	86	81	16	9
Portugal	P	45	24	22	41	30	35	22
Spain	E	69	53	18	35	39	41	14
Sweden	S	58	17	15	42	26	46	17
United Kingdom	UK	20	8	5	23	11	67	50
<b>Total</b>	<b>EU15</b>	<b>45</b>	<b>31</b>	<b>16</b>	<b>36</b>	<b>23</b>	<b>37</b>	<b>22</b>
Cyprus	CY	81	59	63	52	61	18	12
Czech Republic	CZ	62	31	31	41	40	29	16
Estonia	EE	143	67	167	37	121	16	7
Hungary	HU	91	59	31	49	51	20	11
Latvia	LV	116	96	86	86	103	11	9
Lithuania	LT	104	108	89	59	89	11	10
Malta	MT	81	59	63	52	61	17	12
Poland	PL	111	99	14	108	90	31	9
Slovakia	SK	81	59	63	52	61	18	12
Slovenia	SL	75	46	29	70	36	22	13
<b>Total</b>	<b>New</b>	<b>102</b>	<b>84</b>	<b>22</b>	<b>86</b>	<b>83</b>	<b>13</b>	<b>10</b>

Source: ECMT Accident Statistics Database (Ref 53)

**Table 4-19 Pedestrian and cycle accidents, 1992-1997**

Country	Abbrev.	Pedestrians		Cycles	
		Rate*	Severity**	Rate*	Severity**
Austria	A	12.1	4.0	14.3	1.4
Belgium	B	8.2	4.2	14.0	1.8
Denmark	DK	13.2	9.2	29.5	3.1
Finland	FIN	15.1	7.8	19.7	4.8
France	F	16.1	5.3	5.8	4.6
Northern Ireland	NI	17.7	3.6	5.1	1.5
Greece	EL	18.3	10.9	1.9	7.2
Ireland	IRL	20.9	7.8	10.2	3.6
Italy	I	8.8	6.5	5.1	4.8
Luxembourg	L	13.5	6.5	3.5	3.4
Netherlands	NL	7.5	4.2	28.8	2.1
Portugal	P	20.1	6.4	3.3	5.7
Spain	E	15.8	7.9	3.4	4.7
Sweden	S	9.6	6.0	19.4	1.9
Great Britain	GB	19.8	2.4	10.6	0.8

Source: CETE (37), from analysis of CARE database

\* number of accidents involving at least one pedestrian/total number of road accidents

\*\* number of pedestrians (cyclists) killed/number of accidents involving at least one pedestrian (cyclist)

key:

highest
medium
lowest

Source: CETE (Ref 37), from analysis of CARE database

**Table 4-20 Fatal accidents involving HGVs and two wheelers or pedestrians in “all areas”\***

Country	Abbrev.	Motorcycle**			Cycle			Pedestrian		
		Total, of which:	Frontal	Lateral	Total, of which:	Frontal	Lateral	Total, of which:	Frontal	Lateral
Austria	AT	12	2	1	1	1	0	17	0	0
Belgium	BE	18	6	8	29	3	21	17	0	0
Denmark	DK	9	2	3	20	2	9	10	0	0
Finland	FI	4	1	2	9	2	4	10	0	0
France	FR	99	21	41	25	2	18	86	0	1
Germany	D	<b>102</b>	<b>18</b>	<b>50</b>	<b>43</b>	<b>3</b>	<b>26</b>	<b>97</b>	<b>0</b>	<b>1</b>
Greece	GR	39	6	22	3	0	2	32	0	1
Ireland	IE	5	2	0	1	0	1	15	0	0
Italy	IT	152	27	99	75	5	54	108	0	2
Luxembourg	LU	<b>4</b>	<b>2</b>	<b>3</b>	0	0	0	2	0	0
Netherlands	NL	31	3	22	65	1	62	22	0	1
Portugal	PT	25	9	10	5	1	2	26	0	0
Spain	ES	67	11	35	11	1	7	88	0	1
Sweden	SV	8	2	5	6	1	5	17	0	0
United Kingdom	GB	55	12	23	34	3	25	105	0	1
<b>Total</b>	<b>EU15</b>	<b>665</b>	<b>123</b>	<b>324</b>	<b>356</b>	<b>25</b>	<b>236</b>	<b>549</b>	<b>2</b>	<b>9</b>
Cyprus	CY	<b>5</b>	<b>2</b>	<b>3</b>	<b>4</b>	<b>1</b>	<b>2</b>	<b>11</b>	<b>0</b>	<b>0</b>
Czech Republic	CZ	<b>29</b>	<b>5</b>	<b>11</b>	<b>26</b>	<b>2</b>	<b>16</b>	<b>29</b>	<b>0</b>	<b>0</b>
Estonia	EE	<b>5</b>	<b>2</b>	<b>3</b>	<b>4</b>	<b>1</b>	<b>2</b>	<b>11</b>	<b>0</b>	<b>0</b>
Hungary	HU	<b>22</b>	<b>5</b>	<b>11</b>	<b>21</b>	<b>2</b>	<b>16</b>	<b>21</b>	<b>0</b>	<b>0</b>
Latvia	LV	<b>5</b>	<b>2</b>	<b>3</b>	<b>4</b>	<b>1</b>	<b>2</b>	<b>11</b>	<b>0</b>	<b>0</b>
Lithuania	LT	<b>5</b>	<b>2</b>	<b>3</b>	<b>4</b>	<b>1</b>	<b>2</b>	<b>11</b>	<b>0</b>	<b>0</b>
Malta	MT	<b>5</b>	<b>2</b>	<b>3</b>	<b>4</b>	<b>1</b>	<b>2</b>	<b>11</b>	<b>0</b>	<b>0</b>
Poland	PL	<b>102</b>	<b>18</b>	<b>50</b>	<b>43</b>	<b>3</b>	<b>26</b>	<b>97</b>	<b>0</b>	<b>1</b>
Slovakia	SK	<b>5</b>	<b>2</b>	<b>3</b>	<b>4</b>	<b>1</b>	<b>2</b>	<b>11</b>	<b>0</b>	<b>0</b>
Slovenia	SL	<b>5</b>	<b>2</b>	<b>2</b>	<b>4</b>	<b>1</b>	<b>2</b>	<b>8</b>	<b>0</b>	<b>1</b>
<b>Total</b>	<b>New</b>	<b>189</b>	<b>39</b>	<b>89</b>	<b>117</b>	<b>11</b>	<b>74</b>	<b>221</b>	<b>1</b>	<b>4</b>
<b>Total</b>	<b>EU25</b>	<b>854</b>	<b>161</b>	<b>414</b>	<b>473</b>	<b>36</b>	<b>309</b>	<b>770</b>	<b>3</b>	<b>13</b>

Values in red calculated as averages from all other countries in same colour band

\* annual average of last 5 years for which data is available

\*\* assumed to include moped

Source: DGTREN Road Accident Database

**Table 4-21 Fatal accidents involving LGVs and two wheelers or pedestrians in “all areas”\***

Country	Abbrev.	Motorcycle**			Cycle			Pedestrian		
		Total, of which:	Frontal	Lateral	Total, of which:	Frontal	Lateral	Total, of which:	Frontal	Lateral
Austria	AT	6	3	1	0	0	0	9	0	0
Belgium	BE	13	4	6	7	1	5	9	0	0
Denmark	DK	8	2	4	9	0	4	17	0	1
Finland	FI	2	1	0	3	1	2	7	0	1
France	FR	56	14	23	10	1	4	44	0	1
Germany	D	65	14	25	13	1	5	69	0	1
Greece	GR	55	10	33	4	1	2	52	1	1
Ireland	IE	4	1	1	2	1	0	15	0	0
Italy	IT	65	14	25	13	1	5	69	0	1
Luxembourg	LU	2	1	1	2	1	1	9	0	0
Netherlands	NL	30	5	20	37	2	28	19	0	0
Portugal	PT	48	22	17	8	4	1	68	1	1
Spain	ES	77	18	35	12	1	7	98	0	1
Sweden	SV	2	1	1	3	0	1	5	0	0
United Kingdom	GB	39	10	16	10	1	4	62	0	2
Total	EU15	496	118	206	138	17	70	552	3	12
Cyprus	CY	2	1	1	2	1	1	9	0	0
Czech Republic	CZ	27	8	14	11	1	7	29	0	1
Estonia	EE	2	1	1	2	1	1	9	0	0
Hungary	HU	27	8	14	11	1	7	29	0	1
Latvia	LV	2	1	1	2	1	1	9	0	0
Lithuania	LT	2	1	1	2	1	1	9	0	0
Malta	MT	2	1	1	2	1	1	9	0	0
Poland	PL	65	14	25	13	1	5	69	0	1
Slovakia	SK	2	1	1	2	1	1	9	0	0
Slovenia	SL	2	1	1	2	1	1	9	0	0
Total	New	136	36	56	52	8	26	189	1	4
Total	EU25	632	154	263	189	25	96	741	4	16

Values in red calculated as averages from all other countries in same colour band

\* annual average of last 5 years for which data is available

\*\* assumed to include moped

Source: DGTREN Road Accident Database

**Table 4-22 Fatal accidents involving bus/coaches and two wheelers or pedestrians in “all areas”\***

Country	Abbrev.	Motorcycle**			Cycle			Pedestrian		
		Total, of which:	Frontal	Lateral	Total, of which:	Frontal	Lateral	Total, of which:	Frontal	Lateral
Austria	AT	2	2	0	0	0	0	4	0	0
Belgium	BE	3	1	1	1	0	1	5	0	1
Denmark	DK	2	1	1	2	0	1	7	1	2
Finland	FI	0	0	0	3	0	1	5	0	1
France	FR	18	4	8	3	0	2	24	0	2
Germany	D	19	4	7	5	0	3	39	0	4
Greece	GR	15	3	9	1	0	1	15	0	1
Ireland	IE	0	0	0	0	0	0	5	0	0
Italy	IT	17	5	9	5	0	4	21	1	4
Luxembourg	LU	0	0	0	0	0	0	2	0	0
Netherlands	NL	4	1	4	10	0	10	19	0	10
Portugal	PT	10	5	3	2	1	1	15	0	1
Spain	ES	14	4	6	3	0	2	30	0	2
Sweden	SV	2	0	1	2	0	2	9	0	2
United Kingdom	GB	15	4	7	5	1	4	76	0	7
Total	EU15	133	34	57	46	4	31	283	4	34
Cyprus	CY	1	0	0	1	0	1	5	0	1
Czech Republic	CZ	6	2	3	3	0	2	11	0	2
Estonia	EE	1	0	0	1	0	1	5	0	1
Hungary	HU	6	2	3	3	0	2	11	0	2
Latvia	LV	1	0	0	1	0	1	5	0	1
Lithuania	LT	1	0	0	1	0	1	5	0	1
Malta	MT	1	0	0	1	0	1	5	0	1
Poland	PL	19	4	7	5	0	3	39	0	4
Slovakia	SK	1	0	0	1	0	1	5	0	1
Slovenia	SL	1	0	0	1	0	1	5	0	1
Total	New	36	9	17	18	2	13	98	2	13
Total	EU25	169	43	73	64	5	43	381	5	48

Values in red calculated as averages from all other countries in same colour band

\* annual average of last 5 years for which data is available

\*\* assumed to include moped

Source: DGTREN Road Accident Database

**Table 4-23 Fatal accidents involving HGVs and two wheelers or pedestrians in “urban areas”\***

Country	Abbrev.	Motorcycle**			Cycle			Pedestrian		
		Total, of which:	Frontal	Lateral	Total, of which:	Frontal	Lateral	Total, of which:	Frontal	Lateral
Austria	AT	4	0	0	8	0	0	11	0	0
Belgium	BE	8	2	4	16	2	12	11	0	0
Denmark	DK	6	2	3	12	1	10	7	0	0
Finland	FI	2	0	1	6	0	2	5	0	0
France	FR	42	6	20	20	0	14	56	0	0
Germany	D	42	6	24	28	1	18	57	0	1
Greece	GR	22	2	14	2	0	1	24	0	0
Ireland	IE	1	0	0	4	0	1	9	0	0
Italy	IT	84	13	59	52	3	40	80	0	1
Luxembourg	LU	2	0	1	0	0	0	1	0	0
Netherlands	NL	10	1	8	32	1	30	12	0	0
Portugal	PT	12	4	5	3	1	2	20	0	0
Spain	ES	15	1	10	4	0	2	30	0	0
Sweden	SV	1	0	1	4	0	3	8	0	0
United Kingdom	GB	17	2	8	22	0	15	63	0	0
Total	EU15	278	40	159	228	9	149	395	1	3
Cyprus	CY	2	0	1	4	0	1	6	0	0
Czech Republic	CZ	10	2	6	12	1	9	14	0	0
Estonia	EE	2	0	1	4	0	1	6	0	0
Hungary	HU	10	2	6	12	1	9	14	0	0
Latvia	LV	2	0	1	4	0	1	6	0	0
Lithuania	LT	2	0	1	4	0	1	6	0	0
Malta	MT	2	0	1	4	0	1	6	0	0
Poland	PL	42	6	24	28	1	18	57	0	1
Slovakia	SK	2	0	1	4	0	1	6	0	0
Slovenia	SL	1	0	0	3	0	1	4	0	0
Total	New	74	10	40	76	2	45	126	0	1
Total	EU25	352	50	199	305	11	193	521	1	4

Values in red calculated as averages from all other countries in same colour band

\* annual average of last 5 years for which data is available

\*\* assumed to include moped

Source: DGTREN Road Accident Database

**Table 4-24 Fatal accidents involving LGVs and two wheelers or pedestrians in “urban areas”\***

Country	Abbrev.	Motorcycle**			Cycle			Pedestrian		
		Total, of which:	Frontal	Lateral	Total, of which:	Frontal	Lateral	Total, of which:	Frontal	Lateral
Austria	AT	2	1	0	1	0	0	6	0	0
Belgium	BE	5	2	3	2	0	2	5	0	0
Denmark	DK	8	2	5	5	1	3	11	0	1
Finland	FI	1	0	0	2	0	0	4	0	0
France	FR	26	5	13	5	0	2	29	0	1
Germany	D	25	4	11	6	0	2	40	0	1
Greece	GR	25	3	16	2	0	1	28	0	0
Ireland	IE	1	0	0	1	0	0	8	0	0
Italy	IT	25	4	11	6	0	2	40	0	1
Luxembourg	LU	1	0	0	1	0	1	5	0	0
Netherlands	NL	9	0	7	11	0	8	11	0	0
Portugal	PT	29	14	10	4	2	1	46	1	1
Spain	ES	22	4	12	3	0	2	44	0	0
Sweden	SV	0	0	0	2	0	1	4	0	0
United Kingdom	GB	16	3	8	6	0	2	44	0	1
Total	EU15	207	43	98	60	7	27	326	2	5
Cyprus	CY	1	0	0	1	0	1	5	0	0
Czech Republic	CZ	13	4	7	4	1	2	18	0	0
Estonia	EE	13	4	7	4	1	2	18	0	0
Hungary	HU	1	0	0	1	0	1	5	0	0
Latvia	LV	1	0	0	1	0	1	5	0	0
Lithuania	LT	1	0	0	1	0	1	5	0	0
Malta	MT	1	0	0	1	0	1	5	0	0
Poland	PL	25	4	11	6	0	2	40	0	1
Slovakia	SK	1	0	0	1	0	1	5	0	0
Slovenia	SL	1	0	0	1	0	1	5	0	0
Total	New	57	12	27	25	4	11	111	1	1
Total	EU25	264	55	125	85	10	38	437	3	6

Values in red calculated as averages from all other countries in same colour band

\* annual average of last 5 years for which data is available

\*\* assumed to include moped

Source: DGTREN Road Accident Database



**Table 4-25 Fatal accidents involving bus/coaches and two wheelers or pedestrians in “urban areas”\***

Country	Abbrev.	Motorcycle**			Cycle			Pedestrian		
		Total, of which:	Frontal	Lateral	Total, of which:	Frontal	Lateral	Total, of which:	Frontal	Lateral
Austria	AT	1	0	0	2	0	1	3	0	0
Belgium	BE	1	0	0	1	0	0	3	0	0
Denmark	DK	1	0	0	2	0	1	5	0	0
Finland	FI	0	0	0	3	0	1	3	0	0
France	FR	10	2	5	2	0	2	21	0	0
Germany	D	10	2	5	4	0	2	31	0	0
Greece	GR	10	2	6	1	0	1	10	0	0
Ireland	IE	0	0	0	0	0	0	3	0	0
Italy	IT	12	3	7	4	0	3	15	0	1
Luxembourg	LU	0	0	0	0	0	0	2	0	0
Netherlands	NL	2	0	1	4	0	4	8	0	0
Portugal	PT	6	3	1	1	1	1	12	0	0
Spain	ES	6	1	3	2	0	1	20	0	0
Sweden	SV	1	0	1	2	0	1	6	0	0
United Kingdom	GB	8	2	4	3	0	2	69	0	1
Total	EU15	73	17	34	32	2	19	213	0	3
Cyprus	CY	0	0	0	1	0	0	4	0	0
Czech Republic	CZ	3	1	2	2	0	1	7	0	0
Estonia	EE	0	0	0	1	0	0	4	0	0
Hungary	HU	3	1	2	2	0	1	7	0	0
Latvia	LV	0	0	0	1	0	0	4	0	0
Lithuania	LT	0	0	0	1	0	0	4	0	0
Malta	MT	0	0	0	1	0	0	4	0	0
Poland	PL	10	2	5	4	0	2	31	0	0
Slovakia	SK	0	0	0	1	0	0	4	0	0
Slovenia	SL	0	0	0	0	0	0	0	0	0
Total	New	19	4	10	14	1	7	67	0	1
Total	EU25	92	21	44	46	3	26	280	0	4

Values in red calculated as averages from all other countries in same colour band

\* annual average of last 5 years for which data is available

\*\* assumed to include moped

Source: DGTREN Road Accident Database

**Table 4-26 Accidents with small two wheelers**

Fatalities

Country	Abbrev.	2 wheeler deaths	Number with gv	% with gv
Austria	A			
Belgium ***	B	148	45	30.4%
Denmark	DK			
Finland	FIN			
France	F			
Germany **	D	284	100	35.2%
Greece	EL			
Ireland **	IRL	21	7	33.3%
Italy	I			
Luxembourg	L			
Netherlands *	NL	340	100	29.4%
Portugal	P			
Spain	E			
Sweden ***	S	53	8	15.1%
United Kingdom	UK	189	50	26.4%
Total	EU15	1,036	310	29.9%

PIA

Country	Abbrev.	2 wheeler casualties	Number with gv	% with gv
Austria	A			
Belgium	B			
Denmark	DK			
Finland	FIN			
France	F			
Germany	D	8,549	701	8.2%
Greece	EL			
Ireland	IRL	562	73	13.0%
Italy	I			
Luxembourg	L			
Netherlands*	NL	4,732	467	9.9%
Portugal	P			
Spain	E			
Sweden	S	11,702	667	5.7%
United Kingdom	UK	3,517	306	8.7%
Total	EU15	29,061	2,214	7.6%

\* 1996      \*\*1998    \*\*\*1999    \*\*\*\*2000

data source: SWOV, November 2001 (9)

Root source:

Belgium

BIVV

NL

TNO (1998 - Dutch only)

D

Federal Statistical Office

UK

DoT

Sweden

CSB

**Table 4-27 Small two wheel victims in Belgium, 1999**

Number	Accidents	Killed	Victims
Total	15,332	178	15,742
right turning HGV	74	10	75
right turning LGV	74	0	81
right turning coach	12	1	12
right turning car	924	0	1,094
Percent	Accidents	Killed	Victims
Total	100.0	100.0	100.0
right turning HGV	0.5	5.6	0.5
right turning LGV	0.5	0.0	0.5
right turning coach	0.1	0.6	0.1
right turning car	6.0	0.0	6.9

Source: SWOV

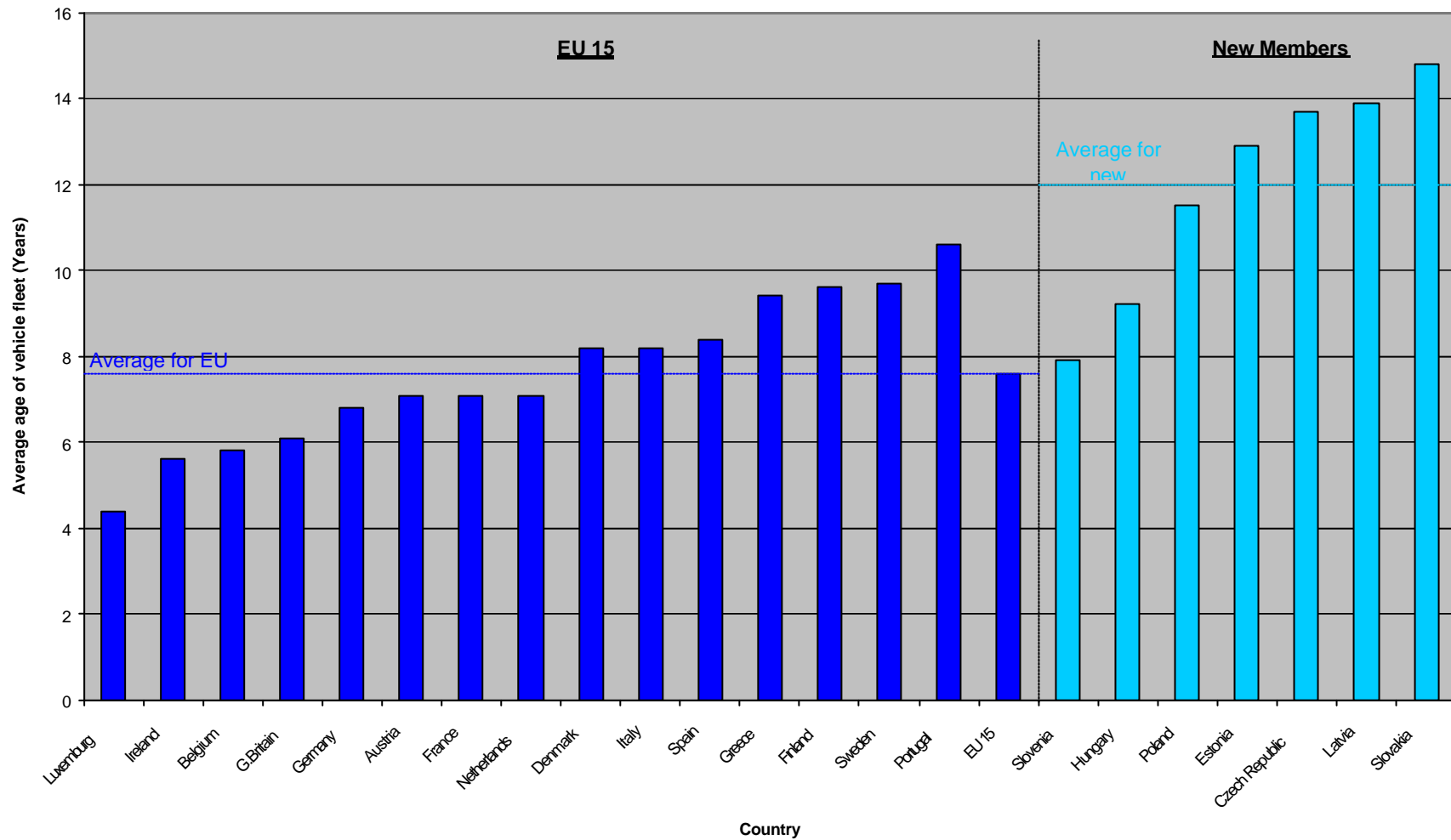
**Table 4-28 Estimated UK accident costs, 2002 (euro)**

Crash/injury severity	Lost output	Human costs	Medical costs	Property damage	Insurance admin	Police cost	Delay cost	Total per crash
<b>All vehicles</b>								
Fatal accident	598,408	1,150,000	8,056	11,172	314	1,999	15,000	1,784,949
Injury accident	6,632	35,000	3,524	3,445	130	91	5,000	53,822
Individual fatality	520,355	1,000,000	7,005	n.a	n.a	n.a	n.a	1,527,360
Individual injury	4,877	26,000	2,591	n.a	n.a	n.a	n.a	33,468
<b>Goods vehicles and buses</b>								
Individual fatality	520,355	1,000,000	8,756	24,287	682	4,346	32,609	1,591,035
Individual injury	4,877	26,000	3,239	6,333	239	162	9,191	50,041

N.a not applicable

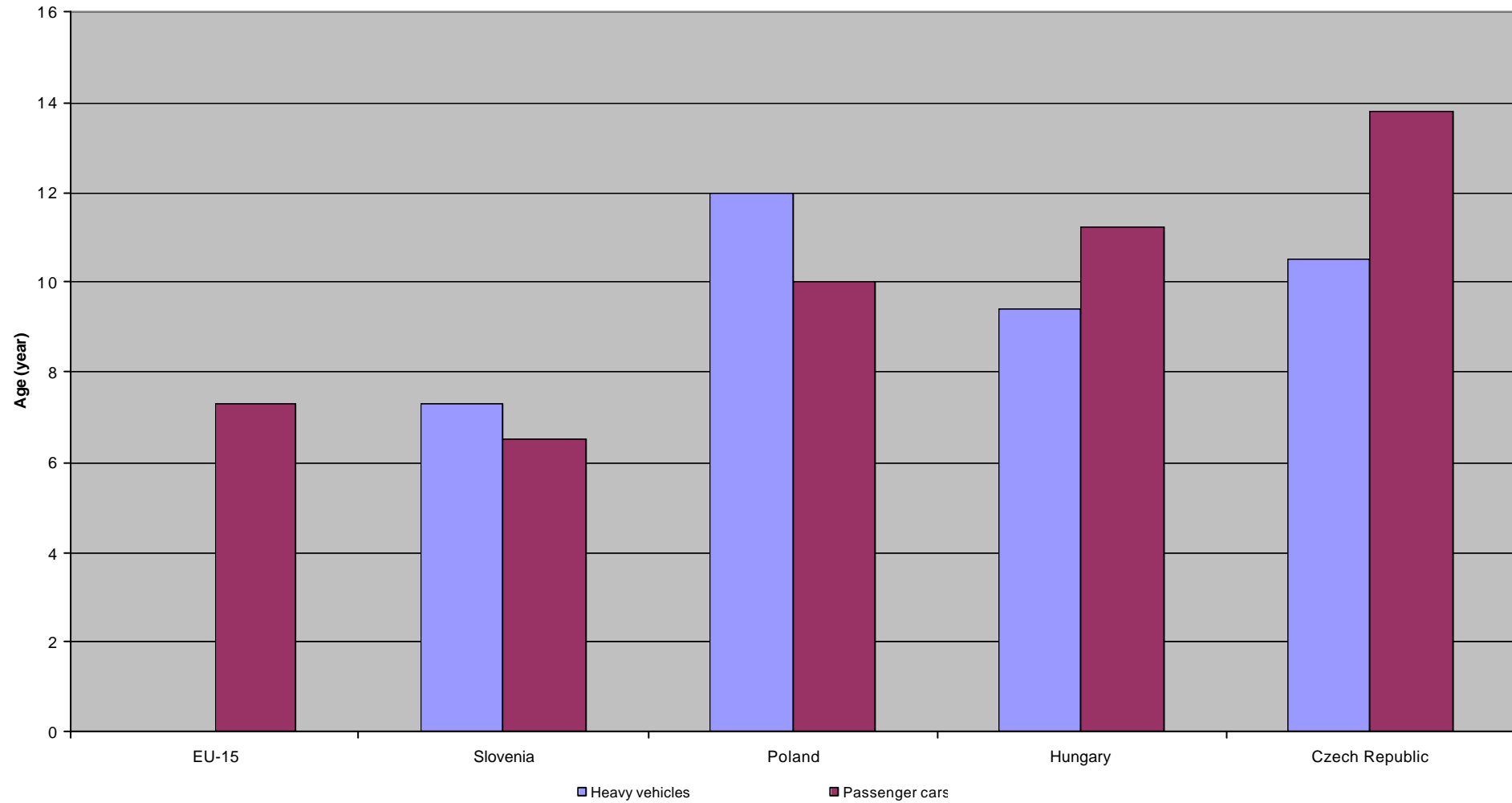
Source: ICF (Ref 30)

Figure 4-1 Comparison of the average age of vehicle fleet by country in 2000



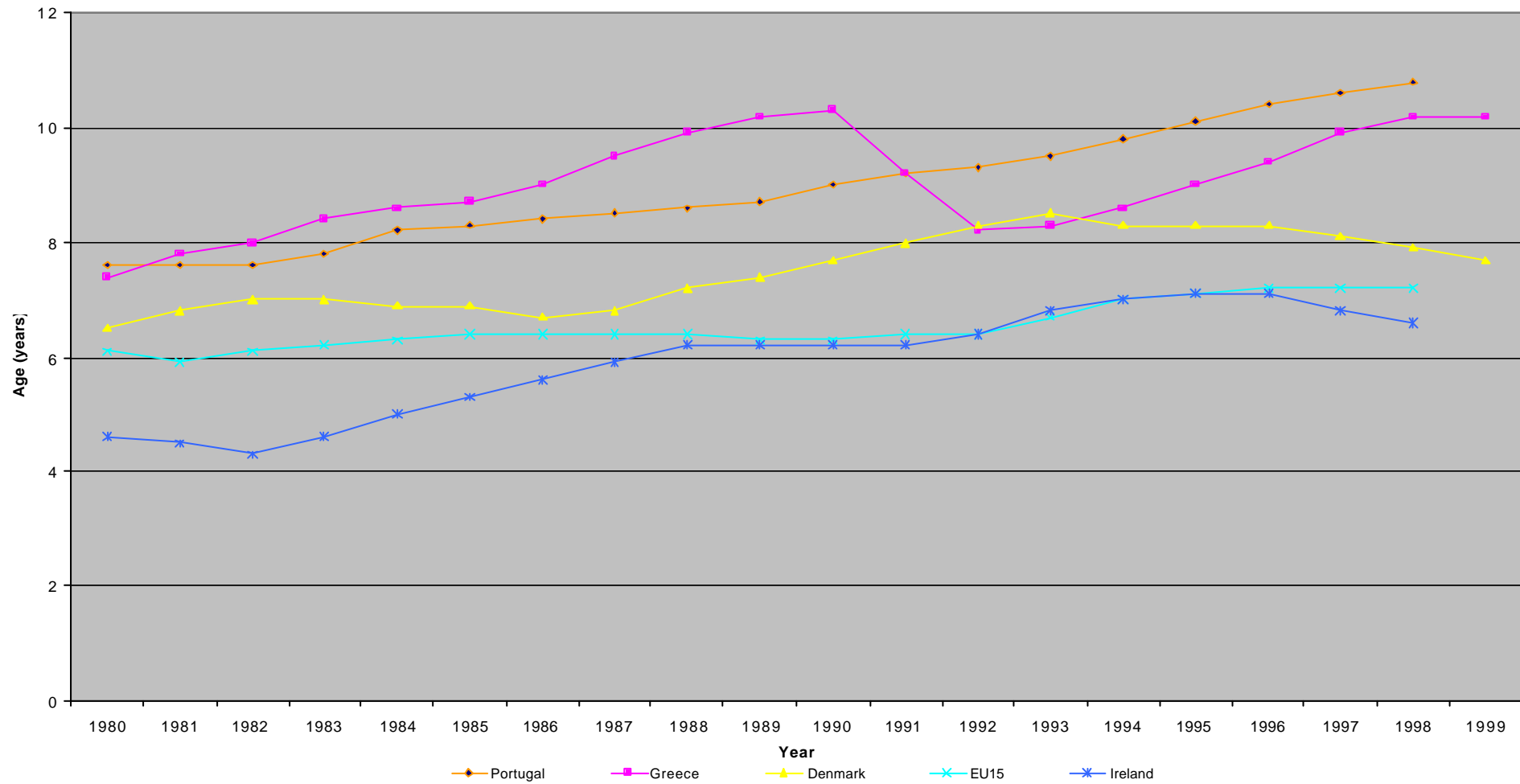
Source: EEA and IRU

Figure 4-2 Average age of passenger cars and heavy vehicles by country



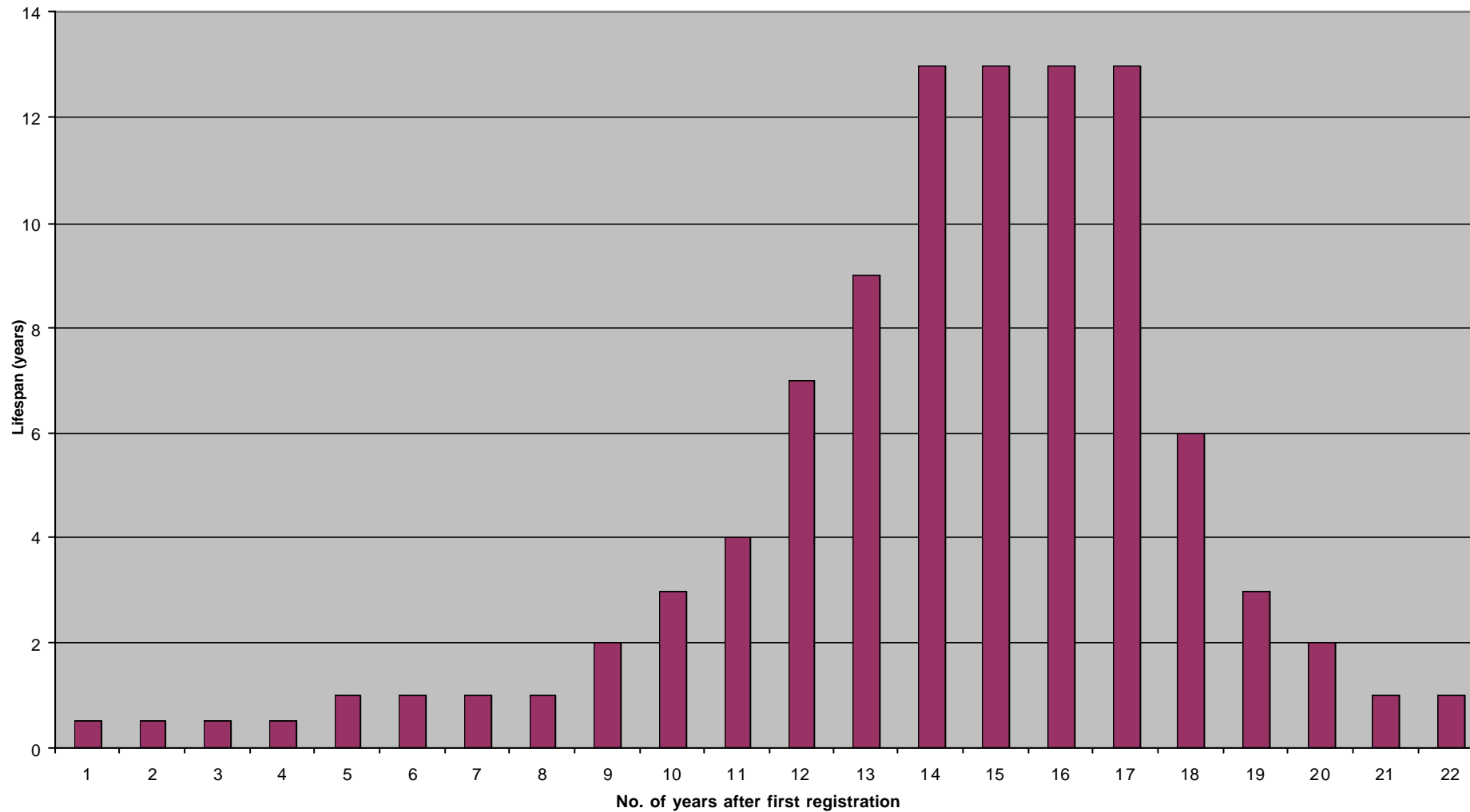
Source: Statistical Analysis of Road Accidents in Slovenia in Period 1996-2000 (Ref 122)

Figure 4-3 Age of vehicle fleet by country



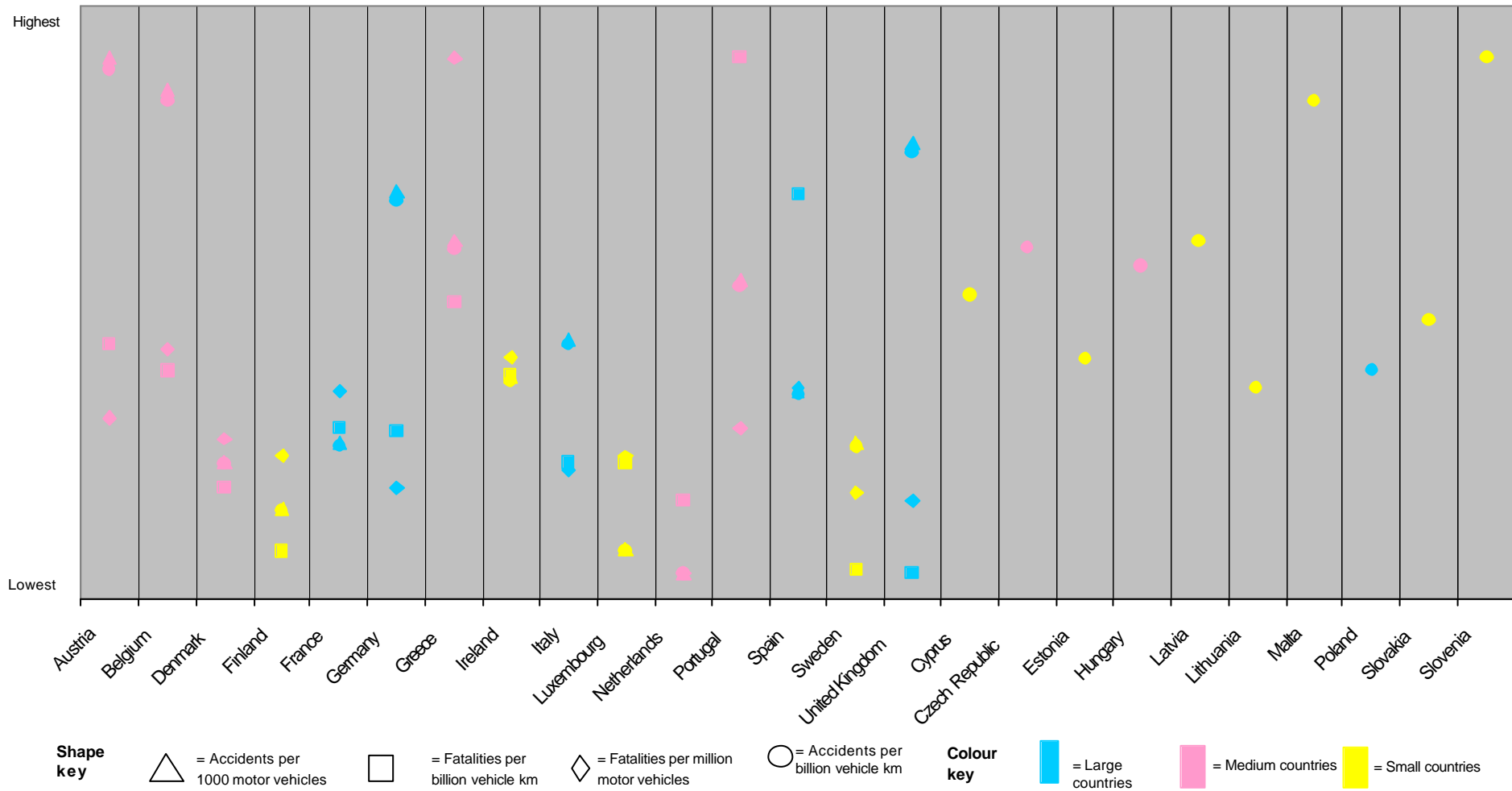
Source: EEA

Figure 4-4 Scrappage of cars - UK



Source: UK Vehicle Licensing

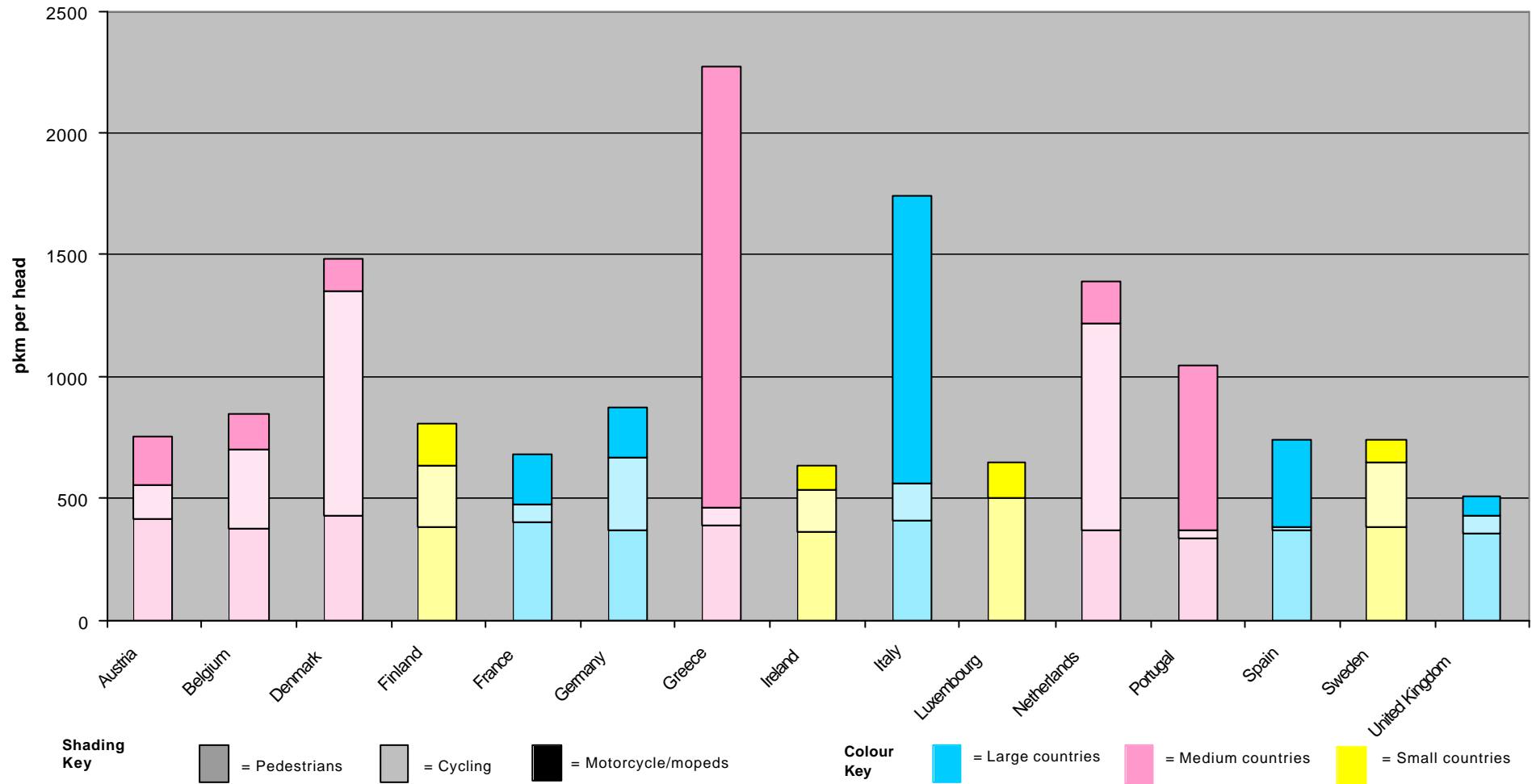
Figure 4-5 Measures of overall accident risk, 2001



Source: Based on UNECE website and IRTAD

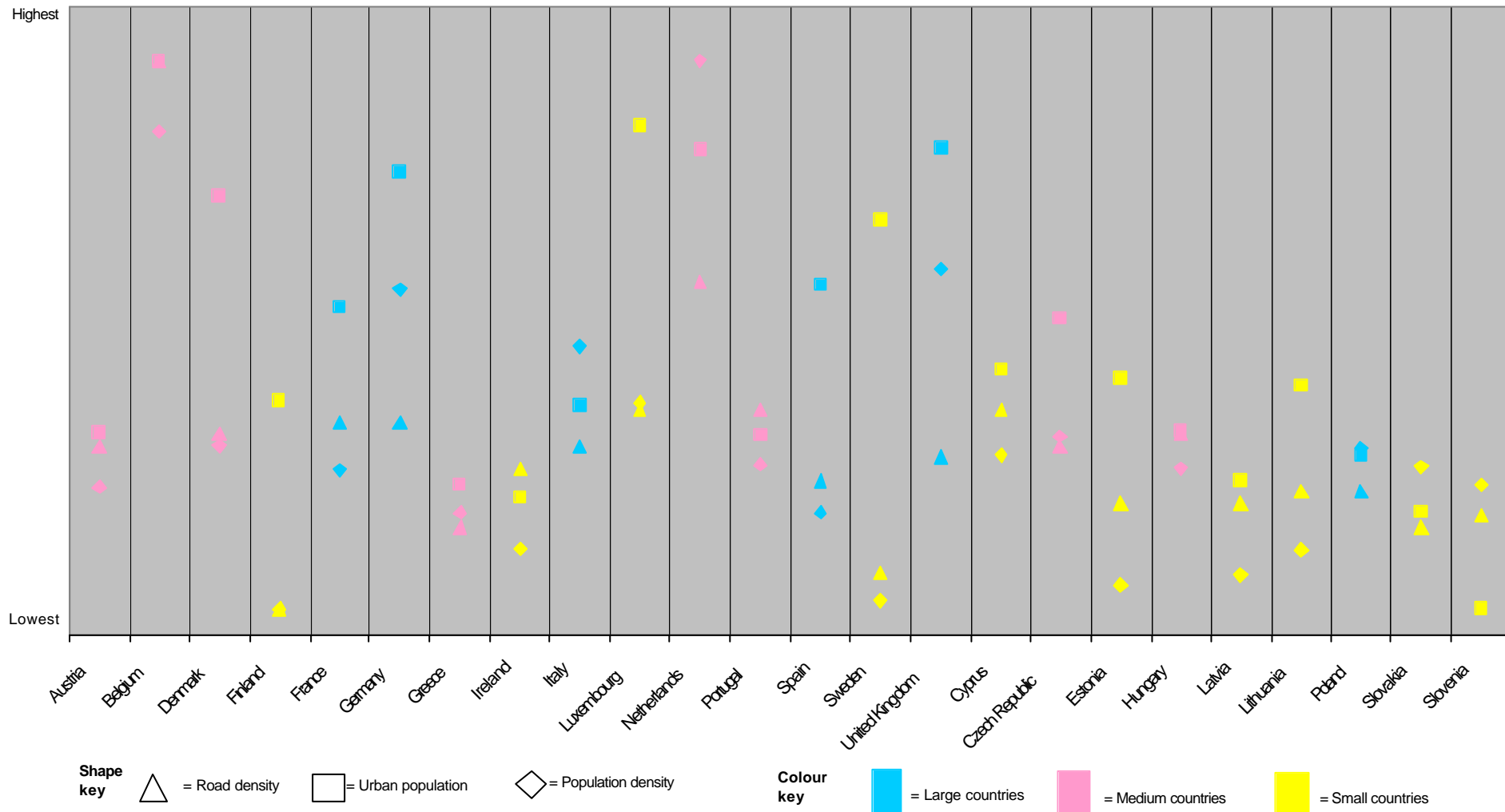


Figure 4-6 Pedestrian and two-wheeler vehicle activity in EU15 by country



Source: World factbook 2000, UN Human Development Report and others

Figure 4-7 Measures of population and road concentration by country



Source: World factbook 2000, UN Human Development Report and others

## 5 FITTING AND RETROFITTING OF MIRRORS

### 5.1 Introduction

The manufacture, fitting and retrofitting of mirrors to European vehicles is a complex arrangement between mirror and vehicle manufacturers and various intermediate distributors.

For the purposes of the study, the arrangement only needs to be understood insofar as to its relevancy with estimation of costs of retrofitting of mirrors. In practice, this study has focused on the vehicle manufacturers.

### 5.2 Manufacturers in Europe

Light commercial vehicles, heavy trucks and buses and coaches manufactured in Europe in 2001 are shown on Table 5-1. Heavy trucks (which are of most interest for the current study) are dominated by the following makes with more than 15,000 HGVs per year produced in the specified countries:

- Mercedes in Germany
- Iveco in Italy
- MAN in Germany and Austria
- Daf in the Netherlands
- Scania, in the Netherlands
- Renault in France
- Volvo in Belgium and Sweden

### 5.3 Fitting of new mirrors and retrofitting to existing vehicles

In February/March 2004, we made enquiries of the vehicle manufacturers concerning the introduction of new mirrors and retrofitting to existing vehicles. In summary, the manufacturers are only beginning to come to terms with the new directive requirements and hence have given little thought to retrofitting.

Actual information gathered so far is that the new generation of mirrors can be retrofitted to some of the existing brackets but not on all makes of goods vehicle. Volvo, for example, has an integrated mirror housing for both existing mirrors. It is assumed to be impossible to fit mirrors with wider view and different dimensions. On the other hand, Daf vehicles can be fitted with different mirrors on the same brackets. Clearly, because all the mirrors are different, the cost of retrofitting will need to be estimated separately for the various types.

#### (a) Daf

Daf reported that the Dutch "blind spot" mirror is being fitted to all goods vehicles delivered in the Netherlands and Belgium. This mirror is an option in other countries. Daf will soon have a front view mirror available, as specified in the new directive. Since this mirror is not obligatory for 36 months, it will be an optional extra for the time being. In general, the mirrors required under Directive 97/2003/EC (**Ref 117**) will be introduced as new models are introduced. For some models there could be a phased introduction. The details will be decided based on market demand, cost etc.

**(b) Renault**

Renault intends to fulfil their obligations under the new regulations by the directive deadlines. The new version of the Mascott being introduced in Spring 2004 will not have the new mirrors; this will also apply to any other new models introduced in 2004 (e.g. the Magnum). Current plans are for a new range called Premium to be delivered from the end of 2005. These will have the new mirrors. No new models are currently planned for 2006.

**(c) Volvo**

Volvo informed us that they are still in the process of designing the new mirrors. The development involves larger housing(s), new type of glass and new design of device for fulfilment of the field of vision in front of the vehicle (class VI mirrors). The development process will take more time than for the main mirrors.

The design process is time-consuming. The main phases of this process are:

- phase 1: theoretical study; with CAD systems this is the easiest and quickest part of the exercise;
- phase 2: working out a prototype; in the case of the new directive everything must be changed (radii of curvature of the glass itself; dimensions of the mirror; housing; etc.);
- phase 3: static and dynamic tests on vehicles; not only field of vision, but also vibrations, aerodynamics, etc. (not less than 10 different kinds of tests have to be performed on a single type of mirror). If the results are not satisfactory, some parameters have to be changed and parts of phases 2 and 3 have to be performed again until there is full compliance with the manufacturer's requirements;
- phase 4: series production. For the mirror to be produced in series the tools have to be defined; this can take place only when the design of the mirror is deemed to be satisfactory;
- phase 5: official type approval (The lead-time is about 6 months, requiring component certification, field-of-view certification on vehicle and the national certification).

In total the whole process is estimated to take about 2.5 years.

In most cases Volvo regard it as impracticable to fit existing vehicles with new mirrors conforming to the new directive (\*). The reason is that a mirror, including its attachment to the body, is designed for one particular type of vehicle, taking account of many parameters, e.g. the body in white (cab structure, doors etc), the "R-point" of the driver's seat, the vibratory context of the mirror, aerodynamics, the style of the cab, etc. Moreover, due to the long life span of heavy vehicles compared to cars (up to 20-25 years) and to the extreme variety of models within vehicle types, redesigning all mirrors for all existing vehicles would entail a huge amount of work and be costly for manufacturers.

*Note:(\*) The Volvo FH-series may be taken as an example. The FH-series was introduced in 1993. Some retrofitting is possible on vehicles manufactured since 2003. FH-series earlier than 2003 requires a change of doors.*

This situation is changing continuously as manufacturers become more conversant with the directive's requirements. It should already be that by the time of preparation of this report (June 2004), manufacturers' plans are much more definite.

#### 5.4 Costs of fitting new mirrors

This is not a straightforward question. Volvo, for example, refer to two distinct elements:

- the cost of the mirror installation itself;
- the overall development cost.

Furthermore, for existing ranges of vehicles, the process must be undertaken twice (once for the present mirrors and once more for the new mirrors).

It will be compulsory for the latest range of mirrors to be fitted to all vehicles. Options will be available, but generally the mirrors will be fitted as a package, to cover the fields of vision required by the new directive. It is particularly difficult to separate out the costs of specific mirrors covering the side and front blind spots.

#### 5.5 Financial cost of retrofitting

The following costs are required for the analysis:

- side-view with existing field of vision requirements;
- front mirror, giving the field of vision required by the new directive;
- camera systems as alternatives to mirrors.

The manufacturers were unable to identify suitable costs for the "new generation" mirrors, for reasons given in section 5.3.

According to **Ref 14**, the cost of a "special mirror" fitted to trucks to eliminate the blind spot in the UK is €225 and a camera-based monitoring system is €900.

In Holland, the cost of a BDS mirror is €78; a DOBLI blind spot mirror retails for €150 for the heated and €111 for the non-heated version. Depending on the method of fitting, a front view mirror might also be around €150. Camera systems were quoted at €600 to more than €1,000 depending on the capability. The cost of mirrors is not expected to vary enormously across EU25.

#### 5.6 Economic cost of retrofitting

The analysis is to be carried out using economic costs (i.e. excluding taxes), including fitting costs and also the opportunity cost of the time the vehicle is out of service for the mirrors to be retrofitted.

Given the difficulty of defining supply cost, it was assumed that taxes and fitting costs cancelled each other out. Straightforward fitting of side-view mirrors was estimated to take one hour, with negligible opportunity cost. Therefore no additional allowance was included.

**Table 5-1 Vehicles manufactured in Europe, 2001**

Group	Make	Country	LGV	HGV	Buses and coaches	Total
Daimler Chrysler	Mercedes	Germany	135,714	85,529	152	221,395
Daimler Chrysler	Mercedes	Spain	56,395			56,395
Evobus	Evobus	Germany	5,408			5,408
Evobus	Evobus	Spain	955			955
Evobus	Evobus	France	520			520
Fiat-Group	Fiat	Poland	7,771			7,771
Fiat-Group	Fiat-Sevel	Italy	126,321			126,321
Fiat-Group	Fiat-Sevel	France	39,374			39,374
Fiat-Group	Iveco Pegaso	Spain	31,155	14,615	1,378	47,148
Fiat-Group	Iveco-Astra	Italy	44,793	40,528	1,930	87,251
Fiat-Group	Iveco-Magirus	Germany		13,409		13,409
Fiat-Group	Iveco-Sevel	France	26			26
Fiat-Group	Seddon Atkinson	UK		542		542
Ford-Group	Ford	Belgium	101,153			101,153
Ford-Group	Ford	UK	100,487			100,487
Ford-Group	Land Rover	UK	13,796			13,796
GM-Group	GM	Spain	37,255			37,255
GM-Group	GM	Portugal	34,742			34,742
GM-Group	IBC	UK	30,911			30,911
GM-Group	Vauxhall	UK	15,448			15,448
Irisbus-Group	Iveco	Italy	1,569		1,274	2,843
MAN-Group	MAN	Germany		33,194	4,610	37,804
MAN-Group	Auwarter	Germany			1,770	1,770
MAN-Group	MAN Steyr AG	Austria		24,167	144	24,311
MAN-Group	ERF	UK		3,086		3,086
MAN-Group	Man-Star	Poland		782	391	1,173
Mitsubishi	Mitsubishi	Portugal	7,464			7,464
Nissan	Nissan	Spain	79,343			79,343
Paccar-Daf-Group	Daf	Netherlands		29,238	666	29,904
Paccar-Daf-Group	Leyland Trucks	UK		9,719	36	9,755
Paccar-Daf-Group	Foden	UK		1,092		1,092
PSA-Group	Citroen	France	46,376			46,376
PSA-Group	Citroen	Spain	73,015			73,015
PSA-Group	Citroen	Italy	41,806			41,806
PSA-Group	Citroen	Poland	508			508
PSA-Group	Citroen	Portugal	29,514			29,514
PSA-Group	Peugeot	France	47,908			47,908
PSA-Group	Peugeot	Spain	60,433			60,433
PSA-Group	Peugeot	Italy	42,225			42,225
PSA-Group	Peugeot	Portugal	20,619			20,619
Renault Group	Renault	France	139,324			139,324
Renault Group	Renault	Spain	50,839			50,839
Renault Group	Sovab	France	94,874			94,874
Scania	Scania	Sweden		8,392	2,533	10,925
Scania	Scania	Netherlands		19,526		19,526
Scania	Scania	France		8,249		8,249
Scania	Scania	Poland		1,210	38	1,248
Scania	Scania	Denmark			53	53
Suzuki	Suzuki	Hungary	384			384
Suzuki	Suzuki	Spain	1,296			1,296
Toyota-Group	Toyota	Portugal	920			920
Toyota-Group	Daihatsu	Italy	9,040			9,040
VW-Group	Skoda	Czech Repub	3,981			3,981
VW-Group	VW	Germany	109,357			109,357
VW-Group	VW-Seat	Spain	50,154			50,154
Volvo AB	Renault Trucks	France	8,335	39,680		48,015
Volvo AB	Renault Trucks	Spain		9,203		9,203
Volvo AB	Volvo Trucks	Belgium		26,228		26,228
Volvo AB	Volvo Trucks	Poland			756	756
Volvo AB	Volvo Trucks	Sweden		16,850	5,409	22,259

Source: AMO (Ref 1)

## 6 COST BENEFIT ANALYSIS

### 6.1 Methodology

#### 6.1.1 Introduction

The analysis has been carried out by spreadsheet. The structure of the spreadsheet is shown diagrammatically in Figure 6-1. The analysis has been carried out in two parts, for Class IV (wide angle)/Class V (close proximity) separately from Class VI (front) mirrors. This reflects the two main blind spots.

Analysis was first carried out for HGV. HGVs (N2 and N3) were treated separately from LGVs (N1). Ideally the analysis for HGV would have been further disaggregated into N2 (<7.5T), N2 (>7.5T) and N3. However, the available data did not support such refinement. The analysis was then repeated for LGV and buses.

Benefits were taken as the reduction in fatalities between goods vehicles and pedestrians, cycles, mopeds and motorcycles. Allowance was made for the associated reduction in injuries. Based on statistical and literature evidence, it was concluded that:

- accidents between two-wheelers and heavy vehicles could be linked to lack of side-view (class IV and V) mirrors;
- accidents between pedestrians and heavy vehicles could be linked to the lack of front mirrors.

The analysis was conducted on this basis.

In Figure 6-1, the model is split into four boxes. The methodology applied to the first three boxes (vehicles, fatalities and CBA inputs) is described in the following paragraphs. The outputs (base case and sensitivities) are covered in sections 6.2 and 6.3.

#### 6.1.2 Vehicles

Forecasts were prepared (by year to 2020), of the number of HGV, by country, which provide the target market for retrofitting. These are the vehicles that are re-registered, rather than registered for the first time (new registrations, which will be subject to the new directive) or scrapped. The analysis is effectively in two parts. The first component was to estimate the total fleet to 2005. The second part was to estimate the numbers of vehicles from that fleet, not already fitted with the new mirrors, which could be retrofitted from 2006.

For EU15, the 2001 fleet and 2001 and 2002 new registrations were obtained from Table 4-6. The 2002 fleet was assumed to be the same as that in 2001. For the new members, the 2001 fleet was obtained from Table 4-2. New registrations in 2002 were estimated at 10% of the 2001 fleet.

New registrations from 2002 to 2020 were calculated by multiplying the preceding year's new registrations by the GDP growth forecasts (see Table 4-10). In the recent past the growth in new registrations has been less than the growth in the vehicle fleet, as the average age of the vehicle fleet has increased. The future vehicle fleet was estimated by multiplying by GDP growth + 0.5%, based on the relationship between fleet growth and GDP observed since 1991.

In 2001 and 2002, the number of vehicles scrapped was assumed to be the same as the number of new registrations. Thereafter, the number scrapped was estimated as the difference between the vehicle fleet in that year and the preceding year, less new registrations.

It was assumed that the percentage of new vehicle registrations to be fitted with the new mirrors under Directive 97/2003/EC would be:

- 2006 registrations, 30%
- 2007 registrations, 100%

Forecasts of the numbers of vehicles to be retrofitted with Class IV (wide angle) and Class V (close proximity) mirrors combined, by country, were made after allowing for the vehicles already fitted with the mirrors and including an estimate of those that will be retrofitted in the particular year. It was assumed that 100% of HGVs in the Netherlands and Belgium would be fitted with side-view blind spot mirrors by 2004. These must be subtracted to obtain the retrofit market.

The number to be retrofitted was assumed to be all those vehicles coming up for re-registration in 2006. The exercise was then repeated for LGV and buses/coaches.

### **6.1.3 Fatalities**

#### **(a) Total**

The total number of fatalities by year by country has been declining significantly, as shown in Table 4-12. It was assumed that recent rates of decline, at an average of 4% per year for EU25, would continue into the future, so providing future fatality forecasts by type of casualty. The fatalities by vehicle type were then calculated by multiplying by the percentages by vehicle type.

#### **(b) By type of vehicle involved**

The basis for this input to the analysis was the data provided by DGTREN in Table 4-20 to Table 4-25.

#### **(c) Fatalities saved**

##### **Class IV/V mirrors**

Fatalities were assumed to be saved only in accidents where the fatalities are cyclists or motorcyclists (including mopeds). This is a reasonable assumption both from the available statistics and from the personal opinions we obtained.

By definition, fatalities saved result from the lateral accidents in Table 4-20 to Table 4-25. To estimate the potential savings in the number of fatalities, adjustments need to be made for:

- the proportion undertaking the “critical manoeuvre” (i.e. the heavy vehicle turning right – or to the left in the UK);
- the effectiveness of fitting the mirrors (i.e. the proportion of fatalities and injuries that would be saved).

The basis for estimating the proportion making the critical manoeuvre is Figure 3-3. Where the proportion of turning vehicles (where lateral impact would occur), turning to



the right, between goods vehicles cycles/mopeds is 56%. This was assumed to apply to both HGV and LGV. For buses a figure of 25% was assumed.

The “effectiveness” was estimated at 40% for HGV based on the work of SWOV described in Chapter 3. Lower figures, of 30% and 10%, were estimated for LGV and buses, respectively.

### **Class VI mirrors**

In the first instance, the fatalities were assumed to be saved in all front accidents between heavy vehicles and two wheelers/pedestrians. The basis data came from Table 4-20 to Table 4-25 projected forward over the evaluation period. Adjustments were made for:

- the proportion undertaking critical manoeuvres (i.e. struck while in the obscured area immediately to the front of the heavy vehicle);
- the effectiveness of fitting the mirrors (i.e. the proportion of fatalities and injuries that would be saved).

There is scarcely any data available on these two items. For all heavy vehicle types it was assumed that 25% of vehicles would be undertaking the “critical manoeuvre”. The same figures for “effectiveness” were adopted as for side-view mirrors.

#### **6.1.4 Other CBA inputs**

##### **(a) Unit accident costs**

A single figure for the cost of all accidents per fatality was estimated, per country. The basic inputs for this calculation were the unit accident costs for the UK, Germany and the Netherlands in Table 4-1 and the various estimates of injuries per fatality referred to in chapter 4. These were adjusted to be representative of a typical accident between a small two-wheeled vehicle and an HGV rather than for all recorded accidents.

As regards the cost of a fatality, it was assumed that the same value would be appropriate whatever the vehicles involved. The figures in Table 4-1 were therefore used for the UK, Germany and the Netherlands.

In order to derive an appropriate fatality value by country, reflecting different price levels, costs were divided into human, labour (including output) and capital (material) costs. Appropriate indices were used to factor cost components to obtain an approximate composite for each of EU25, based on the Netherlands figure as the middle of the three figures for the UK, Germany and the Netherlands.

The estimated number of injuries per fatality for two wheeler and pedestrian is given in Table 4-18. The figures for two wheeler accidents show a substantial variation from 11 in Latvia and Lithuania to 76 in Germany. Figures for pedestrians show a slightly wider range. Generally there are more injuries per fatality in the EU15 than in the new member countries, but is likely to be a result of differences in accident reporting between countries rather than of accident composition. Given that the range of figures is more to do with reporting than incidence of accidents, an average for all countries, of 25 injuries per fatality, was used in the analysis.

Finally, the data presented in Table 4-1 shows that the cost of damage-only accidents can be highly significant. The costs will not be so significant in accidents between heavy vehicles and small two-wheelers/pedestrians. Nevertheless, in view of the

overall enormity of such costs to the economy, it was considered realistic to inflate the total accident costs per fatality by 10% to allow for this cost.

### **(b) Vehicle lifespan (remaining life)**

Vehicle lifespan is required to calculate benefits over the vehicle fleet lifetime. The only data on vehicle life across EU25 is for average age of vehicles. For UK, this is available by vehicle type, as shown on Table 4-7. The average age of HGV is shown to be below the average age of all vehicles, mainly because those over 12 tonnes are significantly younger than the remainder. Buses are significantly older than the average. The relationships observed in the UK were assumed to apply across EU25.

The average lifespan of a vehicle is the age at which it is taken out of service, or scrapped. In the UK, the average lifespan of a car at almost 14 years is approximately twice the average age (between 6 and 7 years). This was again assumed to apply across EU25.

The average lifespan to be input to the cost-benefit analysis relates only to re-registered vehicles (i.e. new vehicles must be excluded). This was applied by subtracting one year from the overall average lifespan.

### **(c) Cost of mirrors**

A single estimate of the cost per mirror was adopted for the analysis, to include fitting, as follows:

- side-view: €150
- front-view: €150
- camera: €1,000.

## **6.2 Results of the CBA**

### **6.2.1 Vehicles**

#### **(a) HGV**

From the analysis spreadsheet, the numbers of HGV available for retrofitting in 2006 are 44.4 million and 46.5 million, for class IV/V and class VI mirrors, respectively.

#### **(b) LGV**

By the same arguments as for HGV, the fleets available for retrofitting in 2006 are:

- 23.2 million for class IV/V mirrors
- 22.5 million for class IV/V mirrors

#### **(c) Buses**

No vehicles were assessed to be fitted with new mirrors prior to 2006. The fleets available for retrofitting in 2006 are therefore:

- 0.7 million for class IV/V mirrors
- 0.7 million for class IV/V mirrors

## 6.2.2 Fatalities

Forecast of fatalities saved are shown in Table 6-1 to Table 6-6. These are:

- highest for HGV, followed by LGV, with buses the smallest;
- higher for Class IV/V mirrors than for Class VI.

## 6.2.3 Cost benefit analysis

The principal measure of the economic value of retrofitting is the benefit cost ratio (BCR). The BCR's include discounting of benefits at 5% per year. The acceptable criterion is that the BCR is greater than 1.0. The results show that only fitting of Class IV/V mirrors to HGV fulfils this criterion.

**Table 6-1 CBA of Class IV & V mirrors on HGV's**

Country	Fatalities saved*	Total accident cost per fatality (€million)	Undiscounted benefits (€million)	Total mirror costs (€million)	Benefit cost ratio (discounted @5%)
Austria	1.8	3.1	5.7	9.2	0.5
Belgium	0.0	2.9	0.0	0.0	0.0
Denmark	28.1	3.1	86.7	8.8	7.3
Finland	14.1	2.9	41.4	9.9	3.0
France	137.0	2.9	403.2	135.6	2.3
Germany	126.3	2.6	325.9	63.7	4.1
Greece	65.6	2.6	172.1	29.1	4.2
Ireland	2.2	3.1	6.9	9.4	0.6
Italy	402.4	2.9	1,184.3	104.4	8.4
Luxembourg	4.8	3.8	18.3	0.3	61.4
Netherlands	0.0	2.9	0.0	0.0	0.0
Portugal	19.2	2.6	50.4	45.0	0.8
Spain	91.6	2.7	246.8	130.3	1.4
Sweden	23.8	2.9	70.1	12.1	4.1
United Kingdom	95.4	3.3	314.4	57.0	4.5
EU 15 total	1,012.4		2,926.3	614.8	<b>3.6</b>
Cyprus	8.1	3.0	24.6	1.8	10.6
Czech Republic	54.5	2.9	156.3	5.0	17.1
Estonia	7.9	2.6	20.7	1.2	10.0
Hungary	34.5	2.8	95.5	6.1	11.2
Latvia	8.1	2.6	20.8	1.6	7.2
Lithuania	11.1	2.6	29.0	1.5	10.6
Malta	19.3	2.9	56.9	0.8	56.2
Poland	142.0	2.6	374.1	30.1	8.1
Slovakia	11.1	2.7	30.0	2.4	6.3
Slovenia	4.0	2.8	11.4	0.8	10.6
New members total	300.5		819.4	51.2	<b>10.7</b>
Total	1,312.9		3,745.7	665.9	<b>4.1</b>

Source: consultant's estimates

Table 6-2 CBA of Class IV and V mirrors on LGV's

Country	Fatalities saved*	Total accident cost per fatality (€million)	Undiscounted benefits (€million)	Total mirror costs (€million)	Benefit cost ratio (discounted @5%)
Austria	1.2	3.1	3.6	38.5	0.1
Belgium	19.4	2.9	57.0	62.2	0.7
Denmark	13.8	3.1	42.7	47.3	0.7
Finland	3.6	2.9	10.7	39.1	0.2
France	50.2	2.9	147.6	731.0	0.2
Germany	41.5	2.6	107.0	303.6	0.3
Greece	73.5	2.6	193.1	161.7	0.8
Ireland	1.8	3.1	5.7	20.0	0.2
Italy	58.5	2.9	172.2	381.1	0.3
Luxembourg	2.7	3.8	10.4	2.1	4.3
Netherlands	84.0	2.9	244.1	119.6	1.5
Portugal	21.1	2.6	55.5	237.8	0.2
Spain	66.8	2.7	179.9	475.9	0.3
Sweden	3.9	2.9	11.6	45.7	0.2
United Kingdom	34.8	3.3	114.6	358.5	0.2
EU 15 total	476.8		1,355.7	3,024.1	<b>0.3</b>
Cyprus	3.1	3.0	9.3	15.9	0.4
Czech Republic	40.9	2.9	117.4	44.9	1.3
Estonia	2.8	2.6	7.4	11.1	0.4
Hungary	25.9	2.8	71.7	54.7	0.9
Latvia	2.9	2.6	7.5	14.1	0.3
Lithuania	4.0	2.6	10.4	13.5	0.4
Malta	7.6	2.9	22.4	6.9	2.4
Poland	55.5	2.6	146.4	270.7	0.3
Slovakia	4.0	2.7	10.8	21.6	0.2
Slovenia	2.2	2.8	6.2	7.3	0.6
New members total	148.9		409.6	460.7	<b>0.5</b>
Total	625.8		1,765.3	3,484.8	<b>0.4</b>

Source: consultant's estimates

Table 6-3 CBA of Class IV and V mirrors on Buses

Country	Fatalities saved*	Total accident cost per fatality (€million)	Undiscounted benefits (€million)	Total mirror costs (€million)	Benefit cost ratio (discounted @5%)
Austria	0.0	3.1	0.0	1.5	0.0
Belgium	0.0	2.9	0.0	2.2	0.0
Denmark	0.6	3.1	1.9	2.2	0.6
Finland	0.4	2.9	1.2	1.6	0.4
France	2.9	2.9	8.6	13.2	0.5
Germany	2.2	2.6	5.8	13.2	0.3
Greece	3.0	2.6	7.9	5.6	0.8
Ireland	0.1	3.1	0.2	1.4	0.1
Italy	3.8	2.9	11.1	13.8	0.5
Luxembourg	0.0	3.8	0.0	0.2	0.0
Netherlands	0.0	2.9	0.0	1.7	0.0
Portugal	0.6	2.6	1.6	3.3	0.3
Spain	1.9	2.7	5.0	9.0	0.4
Sweden	0.8	2.9	2.3	2.1	0.7
United Kingdom	3.1	3.3	10.1	13.9	0.5
EU 15 total	19.3		55.6	85.1	<b>0.5</b>
Cyprus	0.3	3.0	0.9	0.4	1.4
Czech Republic	1.6	2.9	4.5	2.9	0.6
Estonia	0.3	2.6	0.7	0.8	0.4
Hungary	1.0	2.8	2.8	2.9	0.6
Latvia	0.3	2.6	0.7	1.8	0.2
Lithuania	0.4	2.6	1.0	2.3	0.2
Malta	0.8	2.9	2.2	0.2	9.0
Poland	2.9	2.6	7.6	12.5	0.3
Slovakia	0.4	2.7	1.1	1.6	0.2
Slovenia	0.2	2.8	0.6	0.3	1.3
New members total	8.1		22.2	25.8	<b>0.4</b>
Total	27.4		77.8	110.9	<b>0.4</b>

Source: consultant's estimates

Table 6-4 CBA of Class VI mirrors on HGV's

Country	Fatalities saved*	Total accident cost per fatality (€million)	Undiscounted benefits (€million)	Total mirror costs (€million)	Benefit cost ratio (discounted @5%)
Austria	2.3	3.1	7.2	9.2	0.6
Belgium	8.3	2.9	24.5	10.4	1.9
Denmark	4.7	3.1	14.6	8.8	1.2
Finland	2.7	2.9	8.1	9.9	0.6
France	23.9	2.9	70.3	135.6	0.4
Germany	15.2	2.6	39.3	63.7	0.5
Greece	7.5	2.6	19.7	29.1	0.5
Ireland	2.4	3.1	7.4	9.4	0.7
Italy	38.3	2.9	112.6	104.4	0.8
Luxembourg	1.3	3.8	5.1	0.3	17.1
Netherlands	4.3	2.9	12.6	21.0	0.5
Portugal	7.3	2.6	19.2	45.0	0.3
Spain	10.7	2.7	28.8	130.3	0.2
Sweden	2.6	2.9	7.5	12.1	0.4
United Kingdom	13.2	3.3	43.6	57.0	0.6
EU 15 total	144.9		420.5	646.2	<b>0.5</b>
Cyprus	2.2	3.0	6.8	1.8	2.9
Czech Republic	7.6	2.9	21.9	5.0	2.4
Estonia	2.2	2.6	5.7	1.2	2.7
Hungary	4.8	2.8	13.4	6.1	1.6
Latvia	2.2	2.6	5.7	1.6	2.0
Lithuania	3.1	2.6	8.0	1.5	2.9
Malta	5.3	2.9	15.7	0.8	15.4
Poland	22.8	2.6	60.2	30.1	1.3
Slovakia	3.1	2.7	8.3	2.4	1.7
Slovenia	2.1	2.8	6.1	0.8	5.7
New members total	55.5		151.5	51.2	<b>2.0</b>
Total	200.3		572.0	697.4	<b>0.6</b>

Source: consultant's estimates

Table 6-5 CBA of Class VI mirrors on LGV's

Country	Fatalities saved*	Total accident cost per fatality (€million)	Undiscounted benefits (€million)	Total mirror costs (€million)	Benefit cost ratio (discounted @5%)
Austria	1.8	3.1	5.7	37.4	0.1
Belgium	3.5	2.9	10.2	59.8	0.1
Denmark	2.2	3.1	6.7	45.7	0.1
Finland	1.0	2.9	3.0	38.3	0.1
France	12.7	2.9	37.3	710.8	0.0
Germany	9.6	2.6	24.7	294.5	0.1
Greece	10.9	2.6	28.6	160.8	0.1
Ireland	1.8	3.1	5.6	18.2	0.2
Italy	13.5	2.9	39.8	367.6	0.1
Luxembourg	1.0	3.8	4.0	1.8	1.8
Netherlands	5.6	2.9	16.4	115.5	0.1
Portugal	13.8	2.6	36.2	233.8	0.1
Spain	13.9	2.7	37.5	462.2	0.1
Sweden	0.8	2.9	2.3	44.3	0.0
United Kingdom	8.7	3.3	28.6	345.5	0.1
EU 15 total	100.8		286.5	2,936.3	0.1
Cyprus	1.2	3.0	3.5	15.3	0.2
Czech Republic	8.4	2.9	24.0	43.3	0.3
Estonia	1.1	2.6	2.8	10.7	0.1
Hungary	5.3	2.8	14.7	52.8	0.2
Latvia	1.1	2.6	2.8	13.6	0.1
Lithuania	1.5	2.6	4.0	13.0	0.1
Malta	2.9	2.9	8.5	6.7	0.9
Poland	12.8	2.6	33.8	261.3	0.1
Slovakia	1.5	2.7	4.1	20.9	0.1
Slovenia	0.8	2.8	2.4	7.1	0.2
New members total	36.6		100.7	444.7	0.1
Total	137.4		387.2	3,381.0	0.1

Source: consultant's estimates

**Table 6-6 CBA of Class VI mirrors on Buses**

Country	Fatalities saved*	Total accident cost per fatality (€million)	Undiscounted benefits (€million)	Total mirror costs (€million)	Benefit cost ratio (discounted @5%)
Austria	0.4	3.1	1.1	1.5	0.5
Belgium	0.4	2.9	1.1	2.2	0.4
Denmark	0.5	3.1	1.4	2.2	0.4
Finland	0.2	2.9	0.6	1.6	0.2
France	1.4	2.9	4.1	13.2	0.2
Germany	1.1	2.6	2.9	13.2	0.2
Greece	1.1	2.6	3.0	5.6	0.3
Ireland	0.1	3.1	0.2	1.4	0.1
Italy	1.8	2.9	5.2	13.8	0.3
Luxembourg	0.0	3.8	0.0	0.2	0.0
Netherlands	0.2	2.9	0.6	1.7	0.3
Portugal	1.0	2.6	2.6	3.3	0.4
Spain	1.2	2.7	3.3	9.0	0.2
Sweden	0.1	2.9	0.2	2.1	0.0
United Kingdom	1.3	3.3	4.2	13.9	0.2
EU 15 total	10.7		30.6	85.1	<b>0.3</b>
Cyprus	0.1	3.0	0.2	0.4	0.4
Czech Republic	0.7	2.9	2.1	2.9	0.3
Estonia	0.1	2.6	0.2	0.8	0.1
Hungary	0.5	2.8	1.3	2.9	0.3
Latvia	0.1	2.6	0.2	1.8	0.0
Lithuania	0.1	2.6	0.3	2.3	0.0
Malta	0.2	2.9	0.6	0.2	2.2
Poland	1.4	2.6	3.8	12.5	0.1
Slovakia	0.1	2.7	0.3	1.6	0.1
Slovenia	0.1	2.8	0.2	0.3	0.3
New members total	3.3		9.0	25.8	<b>0.2</b>
Total	14.0		39.6	110.9	<b>0.2</b>

Source: consultant's estimates

### 6.3 Sensitivity tests

The following sensitivity tests were undertaken:

- use of cameras rather than mirrors;
- fatality rates stay constant over time rather than 4% annual decline;
- mirror costs 50% more than stated (to allow for greater sophistication of “new generation” mirrors).
- fatalities 10% more than estimated (to allow for possible under-reporting);
- using accident data for urban areas only (rather than all areas).

Results of the sensitivity tests are shown in Table 6-7, in terms of the benefit cost ratio.



**Table 6-7 Sensitivity analysis**

Scenario: for EU25 totals	Side view			Front-view		
	HGV	LGV	Bus	HGV	LGV	Bus
Base case	4.1	0.4	0.4	0.6	0.1	0.2
Cameras rather than mirrors	0.6	0.1	0.1			
Increased Mirror Costs + (50%)	2.7	0.2	0.3			
Constant fatality rates	5.5	0.5	0.6			
10% increase in fatality saving (under reporting)	5.3	0.4	0.6			
Urban only areas	2.3	0.2	0.3			

Source: Consultant's estimates

The results show that only fitting of side view mirrors to HGV is justified.

The main analysis assumes that legalisation is enacted in time for vehicles to be retrofitted by 2006. This is an optimistic assumption; nevertheless, any delay will reduce the effectiveness of the measure since the market for retrofitting will be reduced each year as new vehicles, already equipped with new mirrors, replace scrapped vehicles.

The EC's preferred measure of the potential effectiveness of retrofitting is the benefit cost ratio. Since both benefits and costs are assumed to be directly related to the size of the vehicle fleet, delays in enacting the new legalisation will reduce both costs and benefits. The benefit cost ratio therefore only declines to the extent that the evaluation period (residual vehicle life) is reduced.

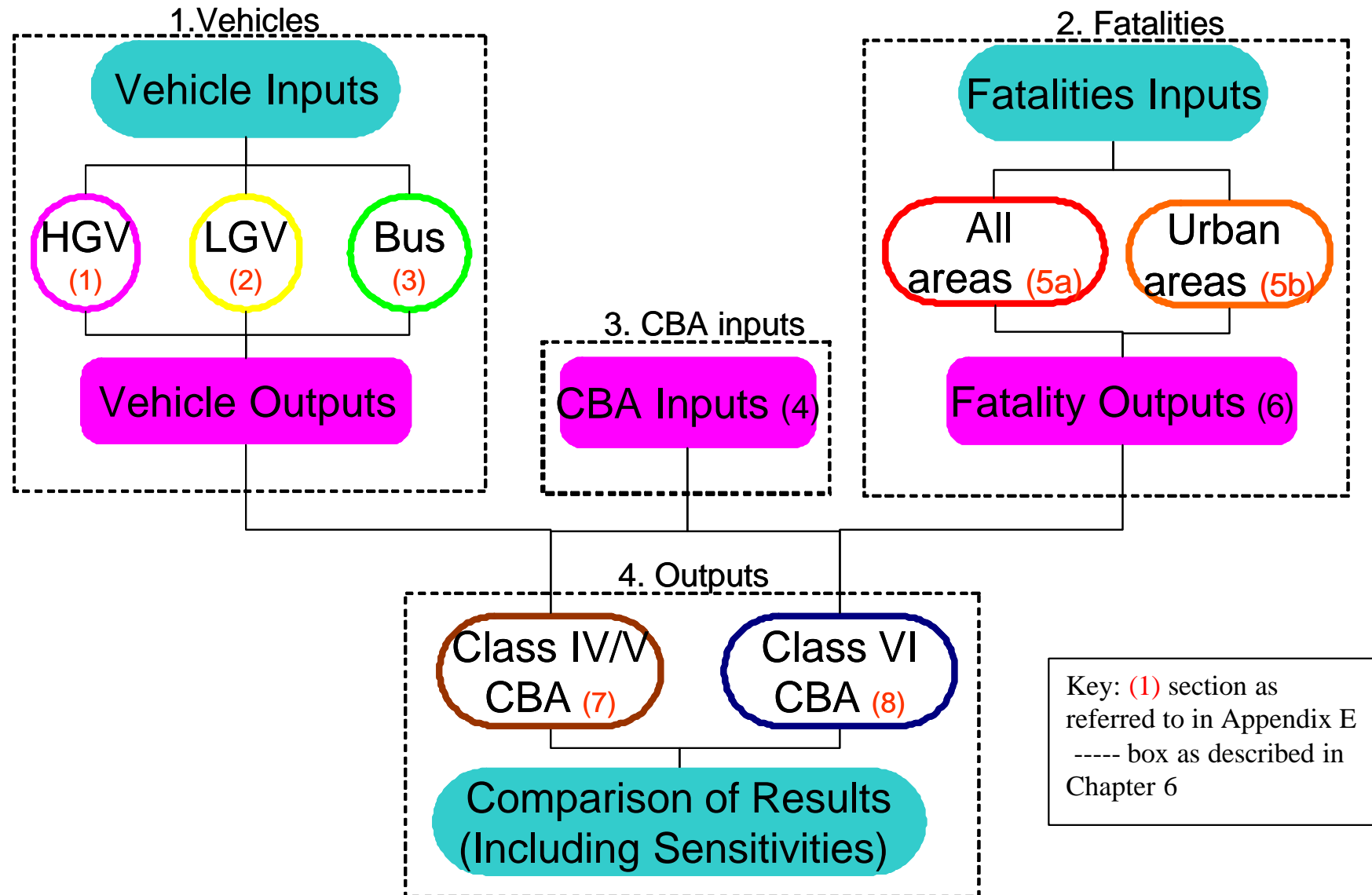
A better measure of the economic value of retrofitting is the net present value (NPV). The effect of delays in retrofitting on the NPV was calculated as shown in Table 6-8.

**Table 6-8 Delays in implementing retrofit legislation**

Scenario;	Side view NPV (€million)			Front-view (NPV €million)		
	HGV	LGV	Bus	HGV	LGV	Bus
2006	2,056	-2,256	-62	-282	-3,111	-86
2007	1,855	-2,328	-66	-305	-3,128	-88
2008	1,714	-2,418	-70	-329	-3,148	-90
2009	1,529	-2,511	-74	-357	-3,168	-92
2010	1,336	-2,604	-77	-385	-3,188	-94

The results show positive values only for HGV fitted with side view mirrors. The NPV declines rapidly if retrofitting is delayed beyond 2006.

Figure 6-1 Spreadsheet intra-linkages



## 7 ADDITIONAL OBSERVATIONS

### 7.1 Background

There are various perceptions of the 'blind spot'. There is general agreement that the blind spot is any area around a vehicle where the driver, either directly through the screen or through the existing mirrors conforming to national or EC regulations, cannot view an object. The problem is particularly severe for drivers of large vehicles, who cannot readily see pedestrians, cyclist, mopeds and motorcycles. Casualties may also arise in cars and vans, and even in the heavy vehicles themselves.

The most severe problem is accepted as being on the nearside of the vehicle, in an arc from slightly forward of the driver's cab, to where the Class V (rear view) mirrors are effective. It is also agreed that the problem can be addressed by a combination of Class II, Class V (close proximity) and Class IV (wide angle) mirrors, or using a camera system. However, there are differences of opinion as to where the blind spot is most severe and hence which mirrors will be most effective.

The increased range of the Class II mirrors required by the new directive seems to be supported and not to be controversial. In any case, there is no data to provide an economic case.

The Class V (close proximity) mirror is an issue in the UK because it is not compulsory for UK registered vehicles of less than 12 tonnes. Also it is believed that not all visiting EU registered vehicles over 12 tonnes are fitted with such mirrors. However, other member states do not see this as an issue because:

- most HGVs are already fitted with such mirrors;
- the blind spot under the near-side door is not seen to be the major risk area.

In Holland and Belgium, the main proponents of the blind spot mirrors, the blind spot of major concern is that not covered by the Class IV (wide angle) mirrors on existing HGVs. That is why the two countries have introduced their own legislation to require fitting of improved mirrors, pending the new directive coming into effect.

The case for Class VI (front) mirrors seems to have arisen in the UK, where a single study provided the economic case. Belgium has also been interested in this aspect. Others see that there could be benefits but do not have any supporting evidence. They support such safety measures because they are popular with the general public.

Driver vision on buses and coaches (M2 and M3) is also limited. Class II (rear view) mirrors are the only compulsory mirrors. There is a significant blind spot between the driver's field of direct vision and that through his Class II (rear view) mirrors. However, data as is available shows incidents between buses/coaches and pedestrians/two wheelers to be much less significant than between goods vehicles and pedestrians/two wheelers. Victims of accidents with goods vehicles can be dragged under the vehicle, increasing the severity, particularly as the driver then cannot see the victim at all. The side of a bus is solid so that victims are rarely dragged underneath. This probably helps explain the fewer fatalities with buses and coaches than with goods vehicles. Fatality reduction is the principal concern and the clear consensus amongst authorities and researchers is that the main problem to be addressed is with goods vehicles, not buses and coaches.

It is recognised that both LGVs and HGVs can have a blind spot problem. There are considerably more LGVs than HGVs. However, the available data shows HGVs are of more concern, particularly because of the increased severity of HGV incidents.

## **7.2 Available data**

A quantified economic analysis can only be as good as the data available. Despite an extensive literature review and contacts, the necessary data for a robust analysis by type of vehicle and field of vision could not be obtained. Considering the data by type:

- That relating to vehicles can be considered reasonably consistent and reliable.
- Overall fatality and injury information suffers from the limitation noted by many analysts, concerning inconsistencies across the EU related to definitions, methods of collection and under-reporting.
- Potential fatality saving is determined by three critical parameters:
  1. the proportion involving heavy vehicles;
  2. the proportion undertaking critical manoeuvres (i.e. the heavy vehicle turning right – or to the left in the UK);
  3. the effectiveness of fitting the mirrors (i.e. the proportion of fatalities and injuries that would be saved).

The only substantial research targeted at these parameters was in Netherlands, for HGV. Extensive assumptions were therefore required.

## **7.3 Practical conclusions on retrofitting**

The analysis is considered to have demonstrated the theoretical viability of retrofitting mirrors to cover the nearside blind spot on HGV. There could be a case for retrofitting to LGV and buses, and for Class VI mirrors. However, our analysis, based on the necessary assumptions, has shown this not to be justified. This generally supports the views from the literature review and interviews.

The analysis shows that retrofitting of Class IV/V mirrors is still justified even if retrofitting is delayed to 2007 or 2008. However, the NPV falls significantly for each year of delay. Also there is a significant overhead cost in retrofitting (development of legislation and perhaps development of suitable mirrors), so the legislation should be introduced as soon as possible for maximum benefit.

The economic analysis could only be undertaken at the level of “Class IV/V” and “Class VI” mirrors. These are essentially broad areas of vision rather than specific mirrors. We were unable to make an assessment of the detailed technical feasibility of retrofitting “new generation” mirrors because these mirrors are still being designed and are largely specific to different manufacturers. Unless this situation changes, the practical solution would therefore appear to be to aim for retrofitting of mirrors with similar specification to those already required in the Netherlands and Belgium.

Finally our research did not show universal support for policy focusing on new mirrors. The broad consensus, even in the Netherlands, is that associated measures are necessary, particularly publicity and driver education. For example, a badly adjusted mirror may be worse than no mirror at all. EU policy on road safety must recognise this.

## APPENDIX A - TERMS OF REFERENCE

### DRAFT TERMS OF REFERENCE

#### **A cost-benefit analysis on the retro-fitting of mirrors and supplementary systems for indirect vision to existing vehicles categories N1, N2, N3, M2, M3**

##### **1. Background**

Every year, more than 40.000 people die as a result of road accidents in the European Union. It is the objective of the Commission to reduce this number by 50% by 2010<sup>1</sup>. A very typical kind of accident is the so-called blind spot accident. Severe accidents may happen when vehicles change direction, e.g. at crossings, junctions or roundabouts, because vehicle drivers are simply unaware of other road users being very close or already beside their vehicles without being visible in their mirrors. Larger vehicles such as trucks and buses represent in such situations a double danger: on one hand when those vehicles are involved, accidents frequently lead to serious injuries or even fatalities of vulnerable road users like pedestrians, cyclists or drivers of smaller motorcycles; on the other hand those vehicles, and especially trucks, have particularly large blind spots. In this context, the Commission has come up with a proposal for a Directive relating to the type-approval of mirrors and supplementary systems in order to increase the field of indirect vision<sup>2</sup>. This Directive will only affect new vehicles. Automatically, the question arises of how to deal with already existing vehicles. To answer this question the present study shall provide sound evidence on costs and benefits of retrofitting these existing vehicles.

##### **2. Objective of the study**

The objective of the study is to assess the introduction of a mandatory retrofit of mirrors and supplementary systems for indirect vision to existing vehicles (N1-N3 and M2 and M3). For this purpose, by means of cost benefit analyses, the following options/scenarios are to be analysed:

- complete extension of the above mentioned Directive to existing vehicles
- extension to particular types of existing vehicles
- extension of particular measures (e.g. parts of the full mirror-set) to existing vehicles or particular types of existing vehicles
- extension to existing vehicles of up to a certain age
- no retrofit to existing vehicles at all

---

<sup>1</sup> White Paper on European transport policy for 2010: time to decide – COM(2001)370 of 12 September 2001.

<sup>2</sup> Proposal for a Directive of the European Parliament and of the Council on the approximation of the laws of the Member States relating to the type-approval of mirrors and supplementary systems for indirect vision and of vehicles equipped with these devices and amending Directive 70/156/EEC, COM(2001)811 final. In the meanwhile, some modifications have been introduced by the Council relating above all to transition periods. The Directive will be probably approved by the Parliament in July 2003.

### 3. Contents of the study

- 3.1. The contractor will compile statistical data on relevant accidents in the Member States in order to provide a sound analysis of the expected benefits. Accident data have to be collected for different types of vehicles and different “fields of visions” referred to in Annex III of the above mentioned Commission Proposal.
- 3.2. A literature review on relevant cost-benefit analyses carried out in the Member States and non-EU countries (USA) is part of the study. If detailed data on the relevant types of accidents are not available for every Member State (e.g. fatalities in accidents with vehicles of category N3 due to a lack of close-proximity mirrors), the literature review might help to fill statistical gaps by commonly accepted estimations.
- 3.3. The contractor will estimate the costs for retrofitting mirrors and supplementary systems for indirect vision covering the different “fields of vision” referred to in Annex III of the above mentioned Commission Proposal. For that purpose the availability of systems for retrofitting meeting the same specifications as systems in the above mentioned Directive shall be analysed. This includes an assessment of the technical feasibility of retrofitting, e.g. the mounting of additional mirrors, provision of the same visibility as specified in Annex III, technical feasibility (aerodynamics, sufficient strength of cab structure...). Furthermore, opportunity costs<sup>3</sup> have to be taken into account.
- 3.4. The cost benefit analyses have to be carried out by Member State for the different options and shall result in recommendations for possible further legal action. It has to be taken into account that in some Member States certain measures for retrofitting mirrors and supplementary systems for indirect vision may have already been implemented. Furthermore, the relevant environment for blind spot accidents might differ from Member State to Member State. E.g., in the NL the amount of cyclists – a group, which is highly affected by blind spots of trucks, is much higher than in other countries. Different situations have to be analysed and their consequences on costs and benefits of the retrofitting have to be taken into account.
- 3.5. Furthermore, the cost benefit analyses have to consider the effects of the above mentioned Directive on the vehicle fleet (e.g. life cycle of a truck in the EU and the Candidate Countries): can a retrofitting Directive still have a significant and cost-efficient impact on road safety?
- 3.6. Finally, a retrofitting Directive might have a positive impact in terms of accelerating the equipment of new vehicles with mirrors or systems for indirect vision. As the above mentioned Directive foresees different transition phases for optional and mandatory equipment a retrofit Directive could push the optional fitting of equipment forward. This effect shall be assessed in further detail.

### 4. Reference documents and other sources of information issued by the Commission

The Commission will provide, or provide reference<sup>4</sup> to, the following documents and sources of information in any event: - access to the Commission’s DGTREN ROAD ACCIDENT database

### 5. Time schedule

---

<sup>3</sup> Opportunity cost in this context is the cost incurred because a vehicle must be taken out of productive service to be retrofitted.

<sup>4</sup> TNO has carried out some research on that topic in the past: Ministry of Transport, Vans in sight: Inventory of additional field of vision improving, TNO 2001; Ministry of Transport, Public Works and Water Management, Criteria for blind-spot detection systems, TNO 2001; TLN/KNV/EVO, Praktijkproef met zichtveldverbeterings-systemen voor vrachtauto’s, TNO 2000; Ministry of Transport, Public Works and Water Management, Fields of vision related victims among small two-wheeled vehicle occupants: a European perspective.

Solid interim results of the study shall be available at the latest 3 months after the date of conclusion of the contract.

The deadline for the final results will be 3 months later than the deadline for interim results.

Regular contacts shall be undertaken with the Commission services. Contact persons are Mr Peter SCHMITZ in Unit E.3, project officer (tel. 0032.2.2986613) and Mr Marco DE SCISCIO for administrative and financial matters (tel. 0032.2.2993793).

#### **6. Submission of the offer**

The Contractor is invited to give an answer as soon as possible. Contact can be taken with the above officials for further clarifications and the submission of the final offer. These clarifications may be introduced in revised terms of reference, if necessary.

## APPENDIX B - CONTACTS

Peter Schmitz	EC (Seconded National Expert, Road Safety and Technology)
Johan van Vooren	Head of Technical Department, Belgian Road Safety Institute
Jan Pelckmans	Belgian Road Safety Institute
Paul Sanders	EMWE
Kees Metselaar	Senior Policy Adviser, Safety Management Division, Netherlands Ministry of Transport
Wilbert van Waes	Dobli
Chris Schoon	Senior Researcher, Netherlands Institute for Road Safety Research (SWOV)
Leo Kusters	General Manager, Advanced Chassis and Transport Systems, TNO Automotive
Dr. Jeremy Broughton	Senior Research fellow, Safety Group
Barry Fenn	TRL Limited
Lars Klit Keigan	Danish Road Directorate
Maria Teresa Sanz Villegas	Directorate General Energy and Transport, EC
Christoph Mrozicki	Gibb Poland
Bengt Sargeant	Manager, Vehicle Regulations and Certification, Volvo
Benno Koch	Regional Chairman, ADF, Berlin
Andy Scott	Department for Transport, UK
Kari Saari	Ministry of Transport and Communications, Finland
Debbie Cowperthwaite	Centre Coordinator, Transport Technology Ergonomics Centre
Gilbert Auwaerts	Belgium Ministry of Communications and Infrastructure
Antonio Erario	Ministry of Transport, Italy
Michel Loccufier	Belgium Vehicle Improvement Service



## APPENDIX C - REFERENCES

**Material obtained**

- Ref 1 Proposal for a Directive of the European Parliament and of the Council on the approximation of the laws of the Member States relating to the type-approval of mirrors and supplementary systems for indirect vision and of vehicles equipped with these devices and amending Directive 70/15/EEC
- Ref 2 Commission Directive 2001/116/EC adapting Directive 70/156/EEC on type-approval of vehicles, December 2000
- Ref 3 Commission Directive 85/205/EEC, February 1986
- Ref 4 Commission Directive 86/562/EEC, November 1986
- Ref 5 Commission Directive 88/321/EEC, May 1988
- Ref 6 Council directive 71/127/EEC relating to the rear-view mirrors of motor vehicles, March 1971
- Ref 7 Criteria for blind-spot de-on systems, TNO, 2001
- Ref 8 Council directive 70/156/EEC of 6 February 1970 relating to type-approval of motor vehicles and their trailers, February 1970
- Ref 9 Fields of vision related victims among small two-wheeled vehicles: a European perspective, TNO, November 2001
- Ref 10 ToR for UK study assessing impact of extending use of mirrors to smaller HGVs, DFT VSE
- Ref 11 Opinion of the Commission on COM(2003) 547 final, September 2003
- Ref 12 OJEC notice redefining vehicle types (amongst other things)
- Ref 13 Trucks.txt
- Ref 14 Text downloaded from DG TREN website
- Ref 15 Common position of the Council relating to type-approval of devices for indirect vision and vehicles with these devices, amending directive 70/156/EEC and repealing directive 71/127/EEC, April 2003
- Ref 16 New registrations in Western Europe, ACEA, 2003
- Ref 17 Average age of vehicles - Accession countries, EEA, August 2002
- Ref 18 Average age of vehicles – EU, EEA, May 2003
- Ref 19 Road transport fact files (one for each country), IRU, 2003
- Ref 20 Journal of Public Transportation article, Vol. 6 No. 3 2003
- Ref 21 The standardisation of accident and injury registration systems (STAIRS), First Results, 1997
- Ref 22 Report for passive safety network, VSRC, February 2002

- Ref 23 An approach to STAIRS in Europe, 1998
- Ref 24 Research Activities 13, SWOV and TLN March 2000
- Ref 25 Extracts from DOBLI blind spot mirror website, 2003
- Ref 26 US Large truck crash facts, FMCSA 2001
- Ref 27 Calculating Transport Accident Costs – Final Report, April 1999
- Ref 28 Regulatory Impact Assessment – Amendments to Rear Vision Directive, Loughborough University
- Ref 29 The danger to young pedestrians from reversing motor vehicles, Paine Paper no 466. Vehicle Design and Research – Australia
- Ref 30 Costs-Benefit Analysis of Road Safety Improvements – Final Report, ICF Consulting with Imperial College Centre for Transport Studies, June 2003
- Ref 31 Case Study: Rear end or chain accidents, SWOV 2003
- Ref 32 Motor Vehicle Safety Standard No. 111; Rearview mirrors, FMCSA
- Ref 33 Article on rear mirrors in ‘Drivers’ March 7 2001, The National Private Truckers Council NPTC 2001
- Ref 34 Rear cross-view mirror performance: Perception and optical measurements Final Report, NHTSA 1998
- Ref 35 Non-planar drivers side rearview mirrors Final Report, NHTSA 2000
- Ref 36 Requests for comments on new rear side technology and Federal Motor vehicle safety standard No. 111, NHTSA 2003
- Ref 37 Evolution and Typology of Accidents and Severity – Case Study, C.E.T.E 2003
- Ref 38 Efforts to Reduce Mirror Blind Spots, The Chronicle of ADTSEA 1997
- Ref 39 Road safety – Results from the transport research programme, EC 2001
- Ref 40 Identifying unsafe driver actions that lead to fatal car-truck crashes, AAA Foundation for Traffic Safety 2002
- Ref 41 Longer Combination vehicle safety data collection, AAA Foundation for Traffic Safety 2000
- Ref 42 2001 large truck crash overview, FMCSA 2002
- Ref 43 Improved visibility for operating large haulage equipment, Michigan Mine Safety & Health Training 1996
- Ref 44 Safety Monitor Newsletter Edition No.44, ETSC November 2002
- Ref 45 Economic valuation of traffic safety – The development of methods for costing accidents in Sweden, University of Lund and IHE 2003

- Ref 46 Highways Economics Note No. 1, DfT, UK 2001
- Ref 47 Estimates of the value of statistical life, SWOV, April 2001
- Ref 48 Economic evaluation of road traffic safety measures – Round Table 117, ECMT
- Ref 49 Lighting, signalling and rear view mirrors for large trucks: A review of human factors considerations, Michigan, Transportation Research Institute 2002
- Ref 50 Geometric visibility of mirror-mounted turn signals, University of Michigan, Transportation Research Institute 2003
- Ref 51 Energy and Transport in figures, DGTREN 2001 & 2003
- Ref 52 Brochure on the ROSEBUD thematic programme, EC
- Ref 53 Accident statistics, 1999-2000, ECMT
- Ref 54 Casualties by traffic participation in 2000, IRTAD
- Ref 55 Transport indicators, EEA 2003
- Ref 56 Presentation on traffic safety , Chalmers University of Technology, Sweden 2002
- Ref 57 Halving the number of road accident victims in the European Union by 2010: A shared responsibility, EC European Road Safety Action programme 2003
- Ref 58 European transport policy for 2010: “Time to decide”, EC
- Ref 59 Improvement of the vision of drivers of trucks and vans, TNO 1998
- Ref 60 Systems for improving fields of vision for trucks, TNO 1999
- Ref 61 Analysis of police reports relating to field of vision and location of victim, TNO, January 2001
- Ref 62 B.D.S.® dead angle mirror system brochure, EMWE
- Ref 63 Mirror field of view in light trucks, minivans, and sport utility vehicles, University of Michigan, Transportation Research Institute 2001
- Ref 64 The accidents and behaviours of bus drivers, Cranfield University 2002
- Ref 65 Missouri state highway system traffic accident statistics, Missouri Department of Transportation 2002
- Ref 66 Road fatality statistics Australia 2002 statistical summary, ATSB 2003
- Ref 67 Australian bus safety, ATSB 2001
- Ref 68 Evaluating and improving fleet safety in Australia, ATSB 2003
- Ref 69 Distractions in everyday driving, AAA Foundation 2003

- Ref 70 Drivers most at risk from distractions outside car, Drivers.com (2001)
- Ref 71 Cost effective EU transport safety measures, ETSC 2003
- Ref 72 Cross-Cultural Models of Road Traffic Accident Risk: Personality, Behavioural, Cognitive and Demographic Predictors, University of Central Lancashire
- Ref 73 Promotion of mobility and safety for vulnerable road users (PROMISING), SWOV (2001) for DGVII
- Ref 74 SUNflower: A comparative study of the development of road safety in Sweden, the United Kingdom, and the Netherlands, SWOV, TRL, VTI 2002
- Ref 75 Accident Cost Case Studies External Accident Cost of Heavy Goods Vehicles, VTI 2002
- Ref 76 The Value of Statistical Life in Road Safety: A Meta-Analysis, Tinbergen Institute 2000
- Ref 77 Belgian Regulation on Mirrors (Belgian Monitor of 11/10/02)
- Ref 78 Extract from Belgian Monitor of 25/12/02
- Ref 79 Distributor Catalogue, Unitruck
- Ref 80 Cost benefit analysis of measures to improve truck safety – draft report, SWOV, January 2004
- Ref 81 Driver field of view from large vehicles, ICE Ergonomics Ltd 1999
- Ref 82 European Union Economic Report, ACEA November 2003
- Ref 83 Extract on vehicle kilometres, Project on Social Attitudes to Road Traffic Risk in Europe
- Ref 84 Road fatalities in Europe – by Road type, Association of British Drivers
- Ref 85 Vehicle scrappage – UK, CFIT
- Ref 86 Care Plus – Glossary, EC
- Ref 87 Distribution of age in the California fleet
- Ref 88 TREMOVE Safety – D9: Appendix II, EUNET WP4
- Ref 89 Safety of Cyclists in the Netherlands: Present and future, SWOV 2000
- Ref 90 Vehicle design for secondary Safety
- Ref 91 Guide to Type Approval for Goods vehicles, UK VCA July 2002
- Ref 92 Labour costs – Annual update 2001, Eiroonline
- Ref 93 GDP per capita of acceding countries, Central Europe News January 2004

- Ref 94 Average Earnings 1999, Eurostat 2001
- Ref 95 Extracts from Regulatory Framework – Type Approval, EC – Enterprise
- Ref 96 How to export – Central and Eastern Europe, CEEBIC Website 2004
- Ref 97 EMWE Brochure, EMWE
- Ref 98 Angle mort: Agissons ensemble, IBSR GOCA
- Ref 99 Attention angle mort, KBC GRACQ VTB VAB
- Ref 100 BDS Brochure
- Ref 101 Document on the 1 million euro rule, SWOV
- Ref 102 Vehicle fleets in SILAQ countries, [www.rec.org](http://www.rec.org)
- Ref 103 Sources for data on traffic injuries and road safety, WHO
- Ref 104 Conforming of European and Dutch site view regulations, [www.dodehoek.nl](http://www.dodehoek.nl)
- Ref 105 Attendees at Road Safety Conference
- Ref 106 Traffic deaths per billion vehicle kilometres in 1999, BAST 38/2001
- Ref 107 New EU – Regulation versus old, IKA
- Ref 108 TERM 2002 33 EU – Average age of the vehicle fleet, EEA May 2003
- Ref 109 Transport of goods by road, Department of Transport UK1996
- Ref 110 Annual Report of the continuing survey of roads goods transport, Department of Transport UK
- Ref 111 End of life vehicle survey – Northern Ireland, EHS NI 2002
- Ref 112 Maltese vehicle licensing statistics, Government of Malta
- Ref 113 Vehicle licensing statistics 2002 (UK), National Statistics
- Ref 114 Vehicle licensing statistics – Ireland, Eirestat 2004
- Ref 115 Road Casualties Great Britain 2002, DfT
- Ref 116 Extracts from DfT website on international traffic/accident comparisons, DfT
- Ref 117 Directive 2003/97/EC of 10 November 2003 relating to type-approval of devices for indirect vision and of vehicles equipped with these devices, EC (in OJEC 29/1/2004)
- Ref 118 UK Government Opinion on Proposed Directive, Select Committee on European Security, July 2002
- Ref 119 Summaries of construction and use regulations for motor vehicles, DfT

- Ref 120 Road Safety Developments in Europe, Road Safety Division of DETR, March 2001
- Ref 121 Production Volumes 2000/2001 per OEM-Group, Make, Country & type, AMO Automotive Marketing
- Ref 122 Statistical Analysis of Road Accidents in Slovenia in Period 1996-2000, Elvir Mujkic and Joze Rovan
- Ref 123 European Energy and Transport - Trends to 2030, DGTREN
- Ref 124 Goods vehicle, bus and coach accident statistics, Police records, Netherlands
- Ref 125 European Road Statistics 2002, ERF
- Ref 126 Polish vehicle data, Christopher
- Ref 127 CARE Plus 2 – Accident Type Glossary, Maria-Teresa
- Ref 128 Extracts from CARE database, Maria-Teresa
- Ref 129 European comparison of taxes on car ownership and use – review of the report, Commission for Integrated Transport
- Ref 130 Blind spot accident data for North Rheinland Westfallen, Police authority
- Ref 131 300 unnecessary deaths in blind spot accidents, ADFC
- Ref 132 Right turning vehicle accidents in Berlin, Berlin Police
- Ref 133 Sidespejle pa lastbiler, RfT
- Ref 134 Transport accidents costs and the value of safety; an update of ETSC cost estimates from 1995 to 2000, Oslo: Institute of Transport economics (unpublished research note)
- Ref 135 The value of statistical life in road safety, 2000, Tinbergen Institute Discussion Paper
- Ref 136 Priorities in EU road safety progress report and ranking of actions, March 2000, EC
- Ref 137 The Economic impact of motor vehicle crashes 2000 – Appendix A, NHTSA
- Ref 138 Economic costs for traffic accidents in Germany 2001, BAST
- Ref 139 Highways Economics Note No.1, 2002, UK
- Ref 140 The costs of road hazard in the Netherlands in 1997, SWOV

## APPENDIX D - TECHNICAL DEFINITIONS

### 1. Vehicle types (from Directive 2001/116/EC)

**M** motor vehicles with at least four wheels designed and constructed for the carriage of passengers

**M1** vehicles designed and constructed for the carriage of passengers and comprising **no more than 8 seats** in addition to the driver's seat

**M2** vehicles designed and constructed for the carriage of passengers and comprising more than 8 seats in addition to the driver's seat, and having a maximum mass **not exceeding 5 tonnes**

**M3** vehicles designed and constructed for the carriage of passengers and comprising no more than 8 seats in addition to the driver's seat, and having a maximum mass **exceeding 5 tonnes**

**N** motor vehicles with at least four wheels designed and constructed for the carriage of goods

**N1** vehicles designed and constructed for the carriage of goods and having a maximum mass **not exceeding 3.5 tonnes**

**N2** vehicles designed and constructed for the carriage of goods and having a maximum mass **exceeding 3.5 tonnes but not exceeding 12 tonnes**

**N3** vehicles designed and constructed for the carriage of goods and having a maximum mass **exceeding 12 tonnes**

In addition, a **moped** has an engine size of less than 50cc, whereas a **motor cycle** is over 50cc.

### 2. Mirrors (from Directive 2003/97/EC)

**Class I** is an interior mirror, mostly used in cars

**Class II** is a large exterior mirror for goods vehicles or buses

**Class III** is a smaller exterior mirror intended for cars

**Class IV** is a 'wide angle' normally fitted on the nearside of Heavy Goods Vehicles, which is particularly useful for surveying the trailer section of an articulated vehicle when negotiating sharp left hand turns.

**Class V** is a 'close proximity' mirror, also fitted on the nearside of goods vehicles, which points downward and gives a view of the road area normally obscured by the passenger door on a high-sided vehicle. It is particularly useful for detecting the presence of cyclists close to the nearside of the vehicle.

**Class VI** is a front mirror.



3. Directives

**Table D 1** Mirror requirements for existing vehicles

Vehicle category	Interior mirror (by class)	Exterior mirrors (by class)				
	I	II	III	IV	V	VI
<b>M1</b>	yes		yes; class 2 an alternative			
<b>M2</b>	alternative to external (offside)	yes (1 on each side)				
<b>M3</b>	alternative to external (offside)	yes (1 on each side)				
<b>N1 (&lt;3.5 tonnes)</b>	alternative to external (offside)		yes (1 on each side)			
<b>N2 &lt; 7.5 tonnes</b>		yes (1 on each side)				
<b>N2 &gt; 7.5 tonnes</b>		yes (1 on each side)		yes (1 on each side) for articulated vehicles	yes (on passenger side)	
<b>N3 (&gt; 12 tonnes)</b>		yes (1 on each side)		yes (1 on each side) for articulated vehicles	yes (on passenger side)	

**Table D 2** Mirror requirements for new vehicles under Directive 2003/97/EC

Vehicle category	Interior mirror (by class)	Exterior mirrors (by class)				
	I	II	III	IV	V	VI
<b>M1</b>	compulsory	optional	compulsory (1 per side); class 2 an alternative	optional (1 or both sides)	optional (1 on each side)	optional
<b>M2</b>	optional	compulsory (1 per side)	not permitted	optional (1 or both sides)	optional (1 on each side)	optional
<b>M3</b>	optional	compulsory (1 per side)	not permitted	optional (1 or both sides)	optional (1 on each side)	optional
<b>N1 (&lt;3.5 tonnes)</b>	compulsory	optional	compulsory (1 per side)	optional (1 or both sides)	optional (1 on each side)	optional
<b>N2 &lt; 7.5 tonnes</b>	optional	compulsory (1 per side)	not permitted	optional (1 on each side)	optional (1 on each side)	1 front mirror optional
<b>N2 &gt; 7.5 tonnes</b>	optional	compulsory (1 per side)	not permitted	compulsory (1 on each side)	compulsory on passenger side; optional on driver's side (may be achievable through IV plus VI)	1 front mirror compulsory (or through camera)
<b>N3 (&gt;12 tonnes)</b>	optional	compulsory (1 per side)	not permitted	compulsory (1 on each side)	compulsory on passenger side; optional on driver's side (may be achievable through IV plus VI)	1 front mirror compulsory (or through camera)

#### 4. Fields of vision

The required fields of vision for these mirrors are shown on Figure D 1 to Figure D 8. First, Figure D 1 shows the field of vision according to EC directives for an existing HGV over 7.5 tonnes. This includes N2 and N3 vehicles, rigid and articulated.

Figure D 2 shows the three blind spots on existing goods vehicles over 7.5 tonnes fitted with mirrors according to current EC directives. Three blind spots are shown, on the near-side, the off-side and to the rear. The blind spot of particular concern is that on the near-side. Figure D2 also identifies areas of impaired visibility, where visibility depends on the size and positioning of the object. The area of impaired visibility to the front of the cab is that addressed by the Class VI mirrors.

Figure D 3 shows the field of vision for an HGV over 7.5 tonnes from the new directive. In Figure D 4, the areas where there is still no visibility or impaired visibility with the mirrors to be fitted to new vehicles, are shown. The Dutch blind spot mirrors are understood to cover the whole of the area shown as having no visibility on the near-side of the vehicle.

Figure D 5 compares the fields of vision on an HGV over 7.5 tonnes, under the new directive and under existing directives. This is repeated on Figure D 6 for an HGV under 7.5 tonnes, on Figure D 7 for an LGV and on Figure D 8 for a bus or coach.

#### 5. Accidents

**Accident (or crash)** a reported incident (therefore including both fatal and injury accidents). According to the CARE database, the situation for the majority of countries is that at least one moving vehicle is involved and at least one injured or killed person.

**Injury** injured in a road accident. Apart from France, hospitalisation or medical treatment is not necessarily required.

**Fatality** a victim who dies within 30 days of the accident

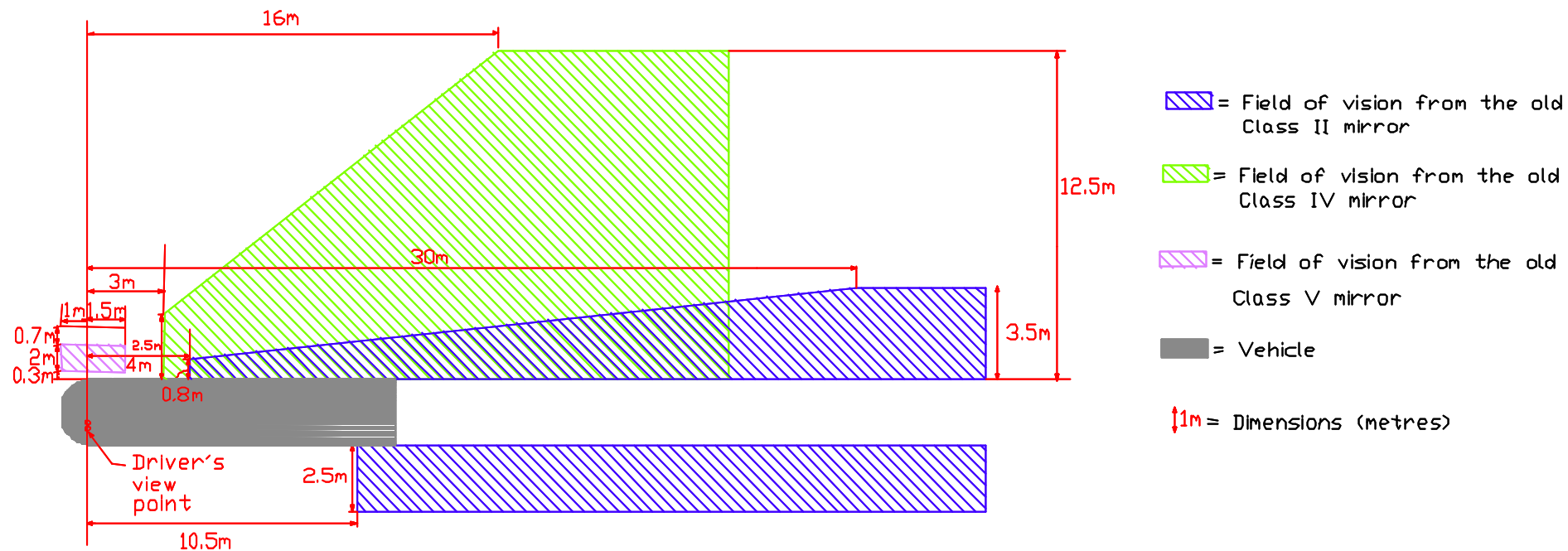
**Fatal accident** an incident involving at least one fatality

**PIA** accident causing at least one injury requiring attention in a hospital emergency room or by a doctor

**Severe injury** injured in a road accident. Normal definition is that hospitalisation is required but this varies by country.

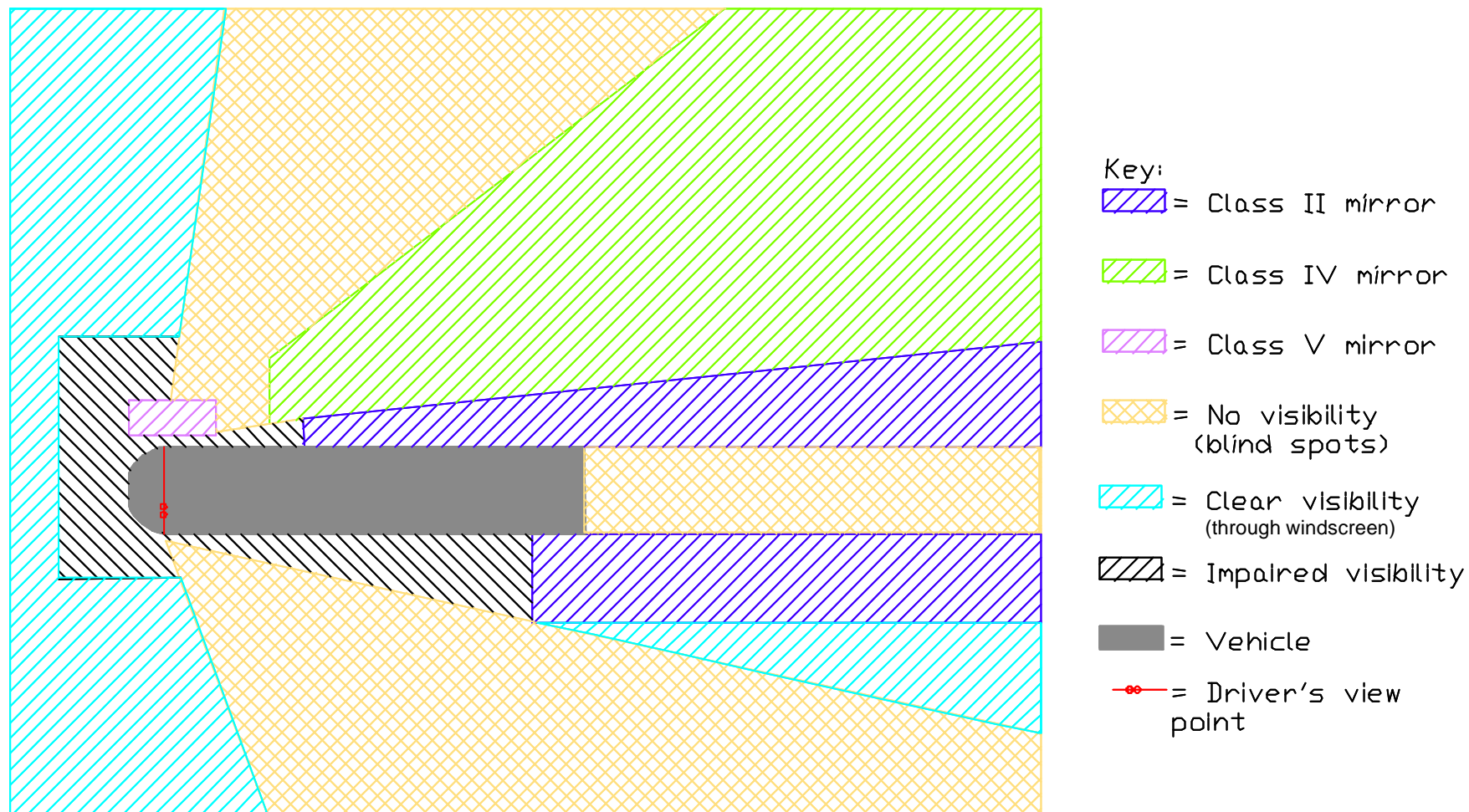
**Slight injury** injured in a road accident. Normal definition is that hospitalisation is not required but this varies by country.

Figure D 1 EU field of vision requirements for an existing HGV over 7.5 tonnes



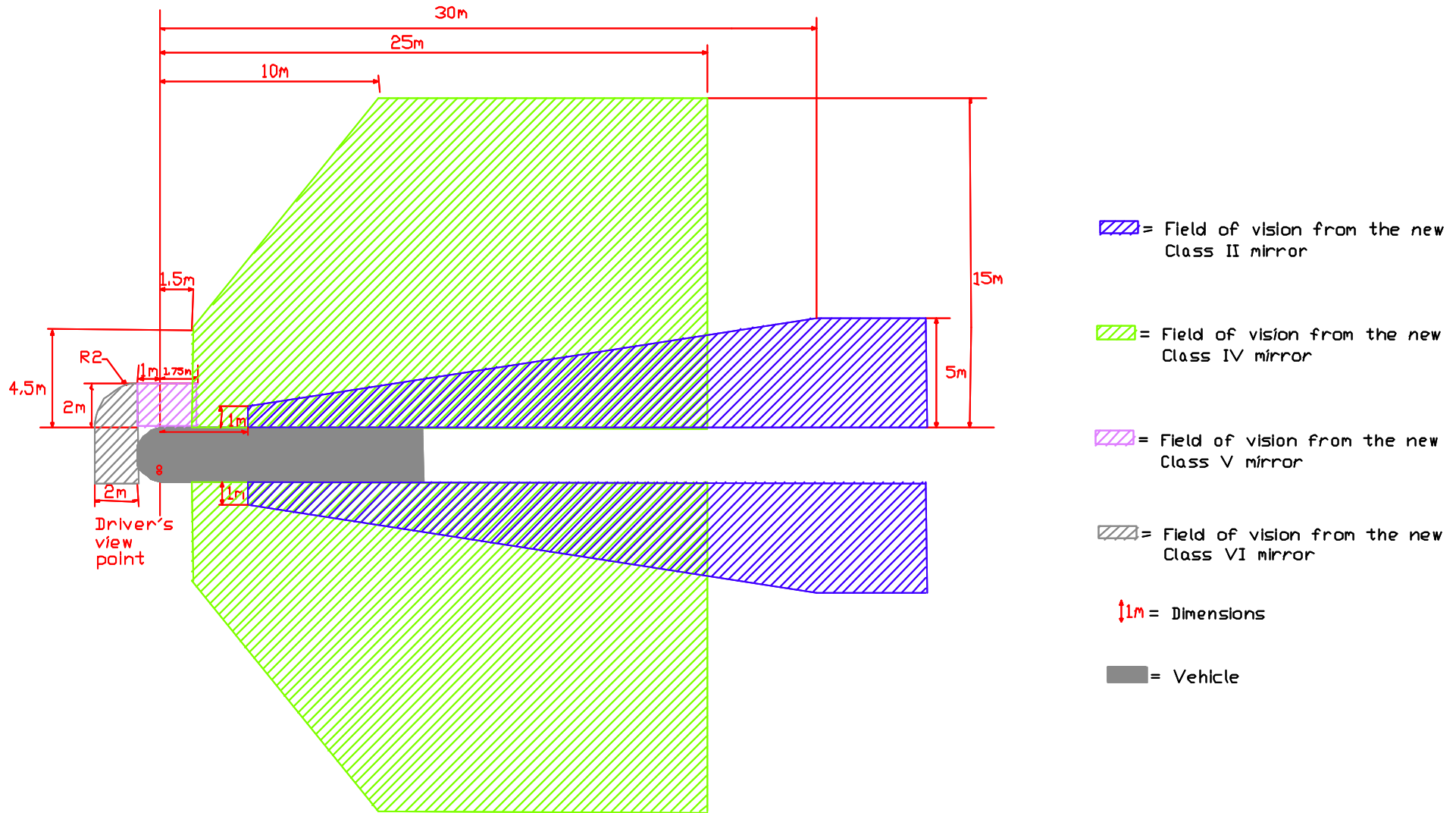
Source: Consultants' analysis

Figure D 2 Blind spots for existing goods vehicles (>7.5 tonnes) in Holland with no “blind spot” mirror



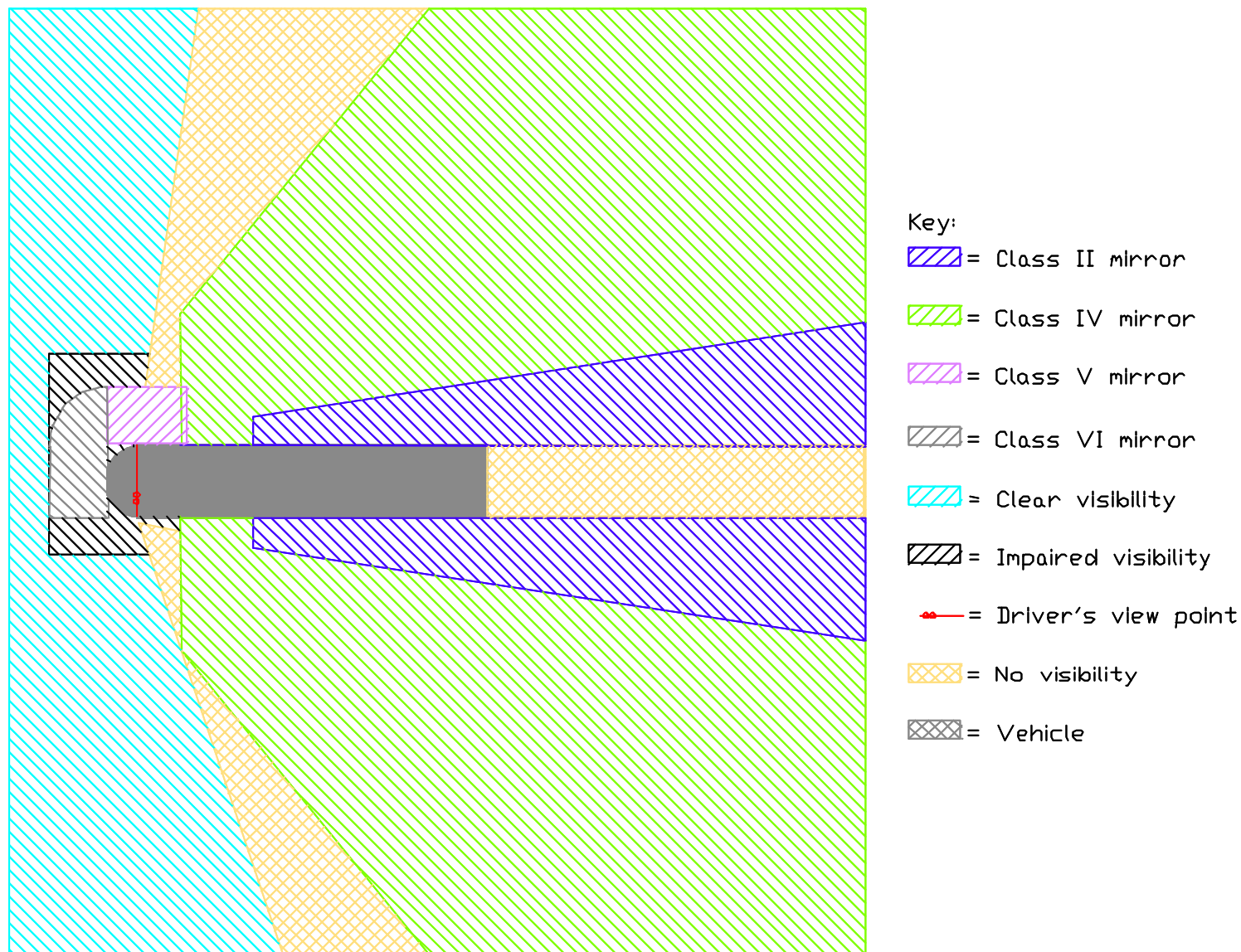
Source: Pamphlets from Dobl

Figure D 3 EU field of vision requirements for an HGV over 7.5 tonnes form Directive 2003/97/EC



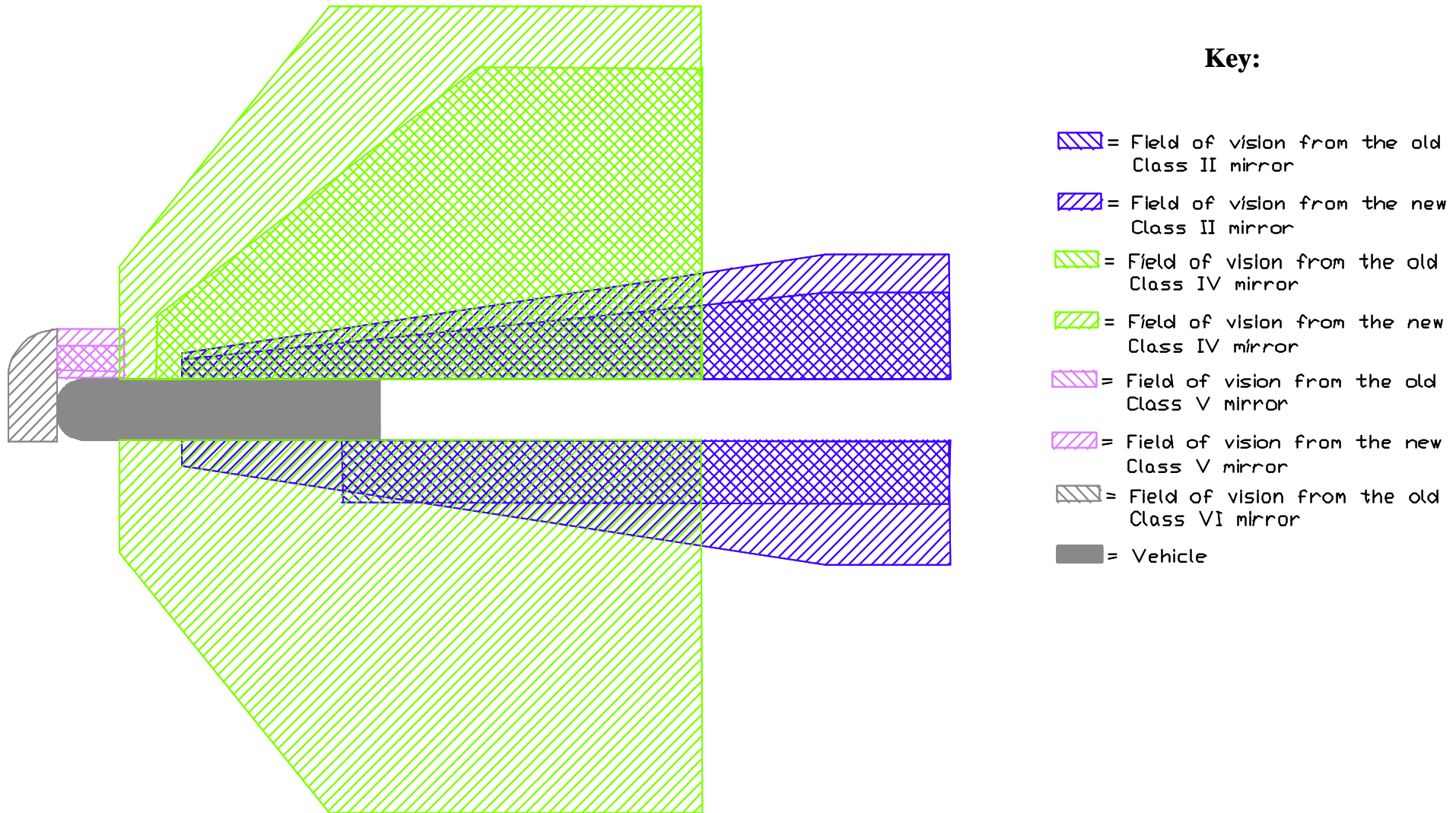
Source: Consultants' analysis

Figure D 4 Areas of no visibility or impaired visibility with mirrors specified by Directive 2003/97/EC



Source: Consultants' analysis

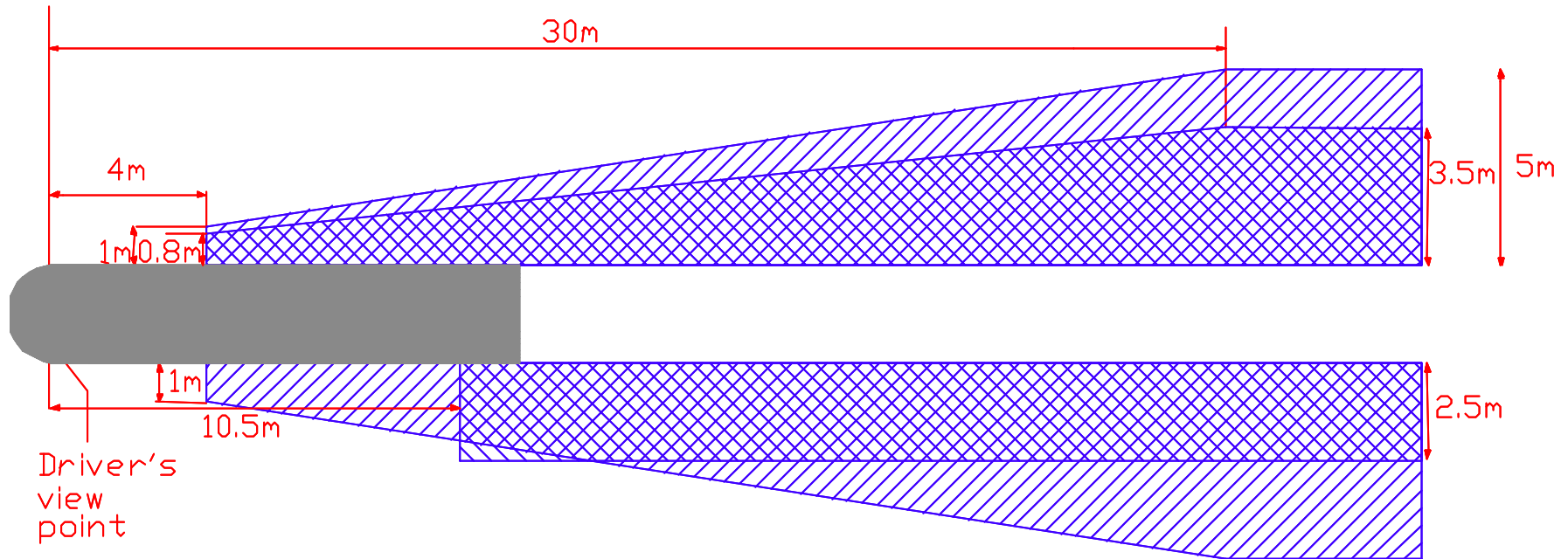
Figure D 5 EU field of vision requirements for existing and new HGVs over 7.5 tonnes



Source: Consultants' analysis



Figure D 6 EU field of vision requirements for N2 HGV under 7.5 tonnes, existing and new

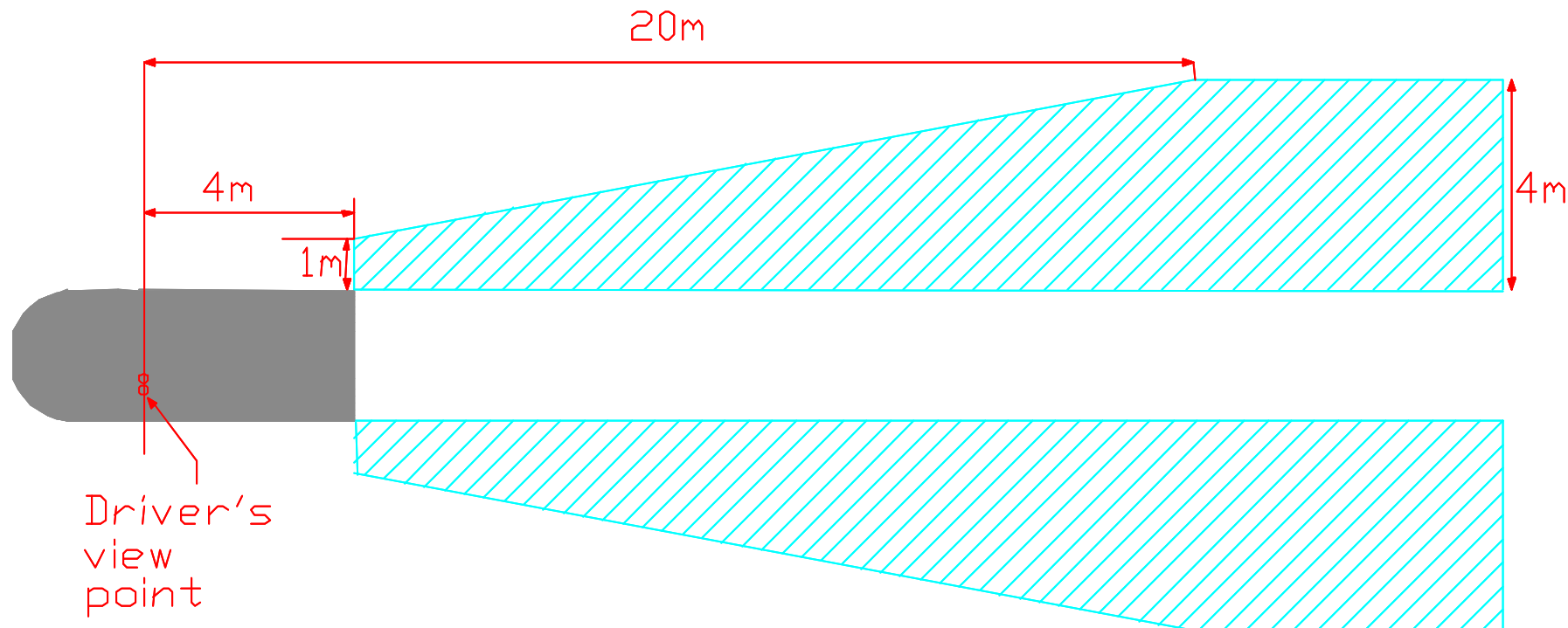


= Field of vision from the old Class II mirror
  = Field of vision from the new Class II mirror

1m = Dimensions (metres)

Source: EC Directives

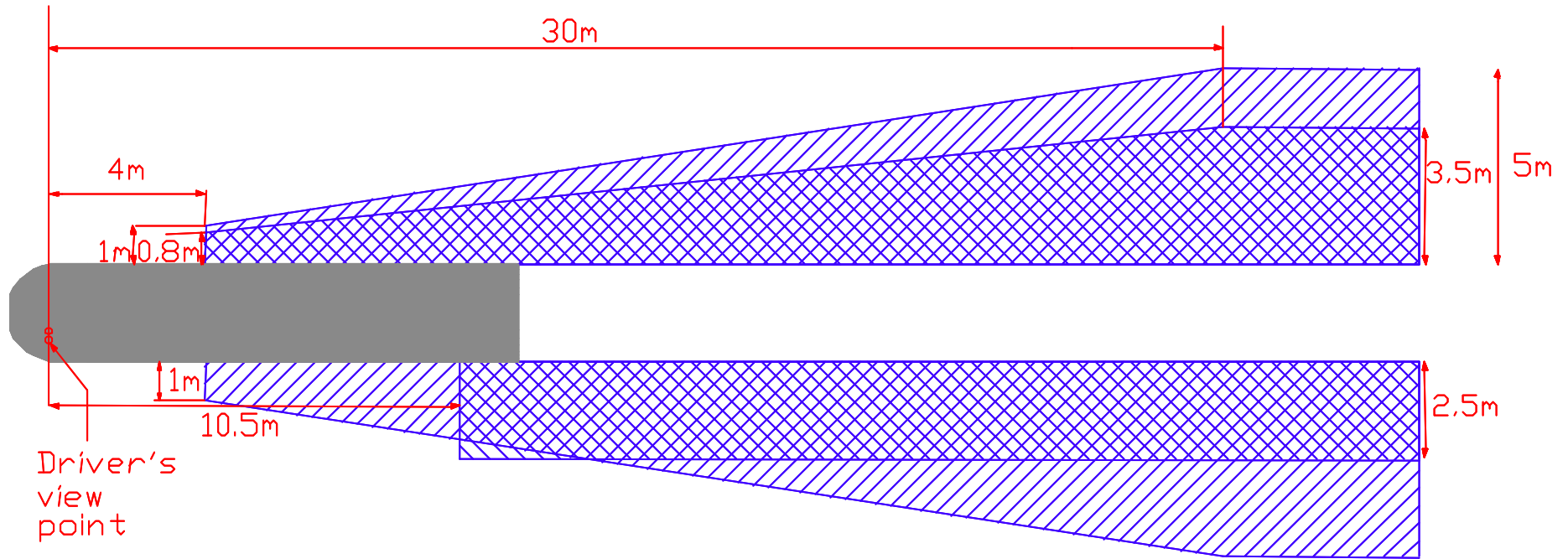
Figure D 7 EU field of vision requirements for existing and new LGVs (N1)





 = Field of vision from Class III mirror  $\updownarrow 1m$  = Dimensions (metres)

Source: EC Directives

Figure D 8 EU field of vision requirements for existing and new bus and coaches (M2 and M3)



 = Field of vision from the old Class II mirror    
  = Field of vision from the new Class II mirror

 = Dimensions (metres)

Source: EC Directives

## APPENDIX E - ANALYSIS SPREADSHEET

### Introduction

For descriptive purposes, the analysis workbook has been split into eight sections, as shown on Figure 6-1. These are:

- **HGV:** This set of spreadsheets estimates the potential HGV market for retrofitting of both Class IV and V (side view) mirrors and Class VI (front view) mirrors.
- **LGV:** repeats the above for LGV.
- **Bus:** repeats the above for buses.
- **Fatality data for all areas:** fatalities for relevant accident types. (A sensitivity test includes urban areas only)
- **Fatality outputs:** estimates fatality savings.
- **CBA inputs:** provides the input parameters for the cost-benefit analysis (CBA).
- **Class IV/V CBA:** results of the CBA for side view mirrors.
- **Class VI CBA:** results of the CBA for front view mirrors

### Section 1: HGV

#### HGV

Forecasts (by year to 2020), the number of HGV by country, which provide the target market for retrofitting.

#### HGV\_Class\_IV\_V

Forecasts the numbers of vehicles to be retrofitted with Class IV (wide angle) and Class V (close proximity) mirrors, combined, by country.

#### HGV\_Class\_VI

Repeats the previous worksheet for Class VI (front) mirrors.

### Section 2: LGV

Repeats the section 1 worksheets, but for LGV.

### Section 3: Bus

Repeats the section 1 worksheets, but for buses and coaches.

### Section 4: Fatality data for all areas

#### Frontal

Gives numbers of frontal accidents for two wheelers and pedestrians between HGV, LGV and buses.

#### Lateral

Gives numbers of lateral accidents for two wheelers and pedestrians between HGV, LGV and buses.

## **Section 5: CBA inputs**

### **GDP\_TG**

Repeats the GDP forecasts in Table 4-10

### **Already\_fitted**

Inputs the proportions of the fleet by country already fitted with wide-angle mirrors, as in the Netherlands and Belgium.

### **Severity**

Provides figures for fatalities and casualties in comparable accidents.

### **Relatives**

Provides indices of different parameters such as travel by mode and country

### **Fatality values**

Provides monetary values for fatality and casualty values by country, expressed in euro million. It also shows a total accident cost per fatality value for all countries examined.

### **Remaining\_life**

Estimates the remaining life of re-registered vehicles.

## **Section 6: Fatality outputs**

### **Side\_fatalities\_HGV**

Forecasts the number of fatalities saved from retrofitting Class IV (wide angle) and Class V (close proximity) mirrors.

### **Front\_fatalities\_HGV**

Repeats the previous worksheet, for Class VI (front view) mirrors rather than Class IV (wide angle) and Class V (close proximity) mirrors.

### **Side\_fatalities\_LGV**

Repeats the above for LGV.

### **Front\_fatalities\_LGV**

Repeats the above for LGV.

### **Side\_fatalities\_Bus**

Repeats the above for buses/coaches.

### **Front\_fatalities\_Bus**

Repeats the above for bus/coaches.

### **Section 7: Class IV/V CBA**

#### **Class\_IV\_V\_HGV\_CBA**

Calculates the benefit cost ratio from retrofitting Class IV and V mirrors, by country, and also allows for sensitivity tests to be undertaken.

#### **Class\_IV\_V\_LGV\_CBA**

Repeats the above for LGV.

#### **Class\_IV\_V\_Bus\_CBA**

Repeats the above for buses/coaches.

### **Section 8:**

#### **Class\_VI\_HGV\_CBA**

Calculates the benefit cost ratio from retrofitting Class VI mirrors, by country, and also allows for sensitivity testing to be undertaken.

#### **Class\_VI\_LGV\_CBA**

Repeats the above for LGV.

#### **Class\_VI\_Bus\_CBA**

Repeats the above for buses/coaches.

## APPENDIX F - QUESTIONNAIRE

EC Directive 2003/97/EC came into force on 29 January 2004, harmonising requirements for indirect vision systems (mirrors and cameras) on new motor vehicles. The EC are considering retrofitting of such systems to existing vehicles and we (Jacobs Consultancy) have been commissioned to analyse the costs and benefits of retrofitting.

We understand that you were a member of the committee advising on the directive.

There are various gaps in our analysis, which you may be able to help us to complete. The most important are as follows:

1. Which types of mirrors are now compulsory for existing goods vehicles in your country and, if not compulsory, which are normally fitted? We would be grateful if you could enter in the following table, where appropriate, either "compulsory" or "normally fitted". Please note whether this applies to one side of the vehicle or to both sides.

Goods vehicle category	Class II rear view mirror	Class III rear view mirror	Class IV wide angle mirror	Class V close proximity mirror	Class VI front view mirror
N1 (less than 3.5 tonnes)					
N2 (3.5 – 7.5 tonnes)					
N2 (7.5 – 12 tonnes)					
N3 (over 12 tonnes) rigid					
N3 (over 12 tonnes) articulated					

2. Who in your country is responsible for research into this subject area? Do you know if they have carried out any relevant research? Please could we have an appropriate name and contact details.

We are particularly interested in accident statistics concerning turning movements between goods vehicles and small two-wheeled vehicles (cycles, mopeds and motorcycles). Do you know if statistics of this type are recorded in your country? An appropriate name and contact details would again be appreciated.

## APPENDIX G - ACCIDENT VALUATIONS BY TYPE & COUNTRY

### UK

		Number	Unit Personal Cost €	Unit Property Cost €	Unit Cost €	Personal Cost € m	Property Cost € m	Total Cost € m
Casualty accidents	Fatal	3,124	2,155,875	15,360	2,171,235	6,735	48	6,783
	Serious	30,521	246,045	6,345	252,390	7,510	194	7,703
	Slight	188,106	21,525	3,645	25,170	4,049	686	4,735
	Total-Non-Fatal	218,627	52,869	4,022	56,891	11,559	879	12,438
	Total Injury Accidents	221,751	82,458	4,182	86,640	18,293	927	19,221
Damage Only Accidents	Damage Only Accidents	3,322,819	0	2,235	2,235	0	7,427	7,427
Total Accidents	Total Accidents	3,544,570	5,161	2,357	7,518	18,293	8,354	26,647
Fatalities	Fatalities	3,618	1,861,572	13,263	1,874,835	6,735	48	6,783
Injuries	Serious	36,564	205,379	5,296	210,675	7,510	194	7,703
	Slight	291,451	13,892	2,353	16,245	4,049	686	4,735
	Total Non-Fatal Casualties	328,016	35,238	2,681	37,918	11,559	879	12,438
All Casualties	All Casualties	331,634	55,137	2,821	57,958	18,293	927	19,221
Total Accident Costs / Fatalities					7,365,424			

### Germany

		Number	Unit Personal Cost €	Unit Property Cost €	Unit Cost €	Personal Cost € m	Property Cost € m	Total Cost € m
Injury Accidents	Fatal	6,025	1,361,096	27,266	1,388,362	8,200	164	8,364
	Serious	79,111	99,928	13,185	113,113	7,905	1,043	8,949
	Slight	290,209	5,151	9,651	14,802	1,495	2,801	4,296
	Total-Non-Fatal	369,320	25,453	10,408	35,861	9,400	3,844	13,244
	Total Injury Accidents	375,345	46,891	10,679	57,569	17,600	4,008	21,608
Damage Only Accidents	Damage Only Accidents	1,998,211	0	6,201	6,201	0	12,392	12,392
Total Accidents	Total Accidents	2,373,556	7,415	6,909	14,325	17,600	16,400	34,000
Fatalities	Fatalities	6,977	1,175,290	23,544	1,198,834	8,200	164	8,364
Injuries	Serious	94,776	83,412	11,006	94,418	7,905	1,043	8,949
	Slight	399,999	3,737	7,002	10,739	1,495	2,801	4,296
	Total Non-Fatal Casualties	494,775	18,999	7,769	26,768	9,400	3,844	13,244
All Casualties	All Casualties	501,752	35,077	7,988	43,065	17,600	4,008	21,608
Total Accident Costs / Fatalities					4,873,188			

### Netherlands

		Number	Unit Personal Cost €	Unit Property Cost €	Unit Cost €	Personal Cost € m	Property Cost € m	Total Cost € m
Injury Accidents	Fatal	1,076	1,446,530	20,665	1,467,195	1,556	22	1,579
	Serious	18,100	199,187	6,268	205,455	3,605	113	3,719
	Slight	89,000	1,035	2,748	3,783	92	245	337
	Total-Non-Fatal	107,100	34,523	3,343	37,866	3,697	358	4,055
	Total Injury Accidents	108,176	48,568	3,515	52,083	5,254	380	5,634
Damage Only Accidents	Damage Only Accidents	1,400,000	0	1,416	1,416	0	1,983	1,983
Total Accidents	Total Accidents	1,508,176	3,484	1,567	5,051	5,254	2,363	7,617
Fatalities	Fatalities	1,163	1,338,320	19,119	1,357,439	1,556	22	1,579
Injuries	Serious	20,190	178,568	5,619	184,187	3,605	113	3,719
	Slight	108,000	853	2,265	3,118	92	245	337
	Total Non-Fatal Casualties	128,190	28,843	2,793	31,636	3,697	358	4,055
All Casualties	All Casualties	129,353	40,617	2,940	43,556	5,254	380	5,634
Total Accident Costs / Fatalities					6,549,574			